

# ERGs

## PART 3

# Historical view



[http://en.wikipedia.org/wiki/Alarik\\_Frithiof\\_Holmgren](http://en.wikipedia.org/wiki/Alarik_Frithiof_Holmgren)

- 1865:
  - The first electroretinogram is recorded by Alarik Frithiof Holmgren.  
*The components of the retinal action potential in mammals and their relation to the discharge in the optic nerve.*  
*Granit R. ; J Physiol. 1933 Feb 8;77(3):207-39.*
- 1903:
  - The electrical response of the eye to a light flash was first described as composed of two waves.  
*[The time relations of the photo-electric changes in the eyeball of the frog / Gotch F. / J Physiol. 1903 Jun 15;29(4-5):388-410]*
    - First: the cornea became negative.
    - Then: a positive wave of larger amplitude appeared.
- 1908
  - Then it was described as being composed of three waves. *[The form and magnitude of the electric response of the eye to stimulation by light at various intensities / W. Einthoven and W.A. Jolly / January 1, 1908 Experimental Physiology, 1, 373-416]*
    - First: a corneal negative wave appears immediately after turning on a light stimulus.
    - Second: a positive wave.
    - Third: a slower positive wave.
  - These authors work was the foundation for the form of analysis of the ERG used to present day.
  - The waves are called **a-**, **b-** and **c-**waves. An additional corneal-positive wave, that is more rarely recorded at the end of the stimulus, is called the d-wave.
  - They suggest that the waves reflect transient chemical processes.

# Historical view

- 1908
  - Then it was described as being composed of three waves. [The form and magnitude of the electric response of the eye to stimulation by light at various intensities / W. Einthoven and W.A. Jolly / January 1, 1908 Experimental Physiology, 1, 373-416]
    - First: a corneal negative wave appears immediately after turning on a light stimulus.
    - Second: a positive wave.
    - Third: a slower positive wave.
  - These authors work was the foundation for the form of analysis of the ERG used to present day.
  - The waves are called **a-**, **b-** and **c-**waves. An additional corneal-positive wave, that is more rarely recorded at the end of the stimulus, is called the d-wave.
  - They suggest that the waves reflect transient chemical processes.

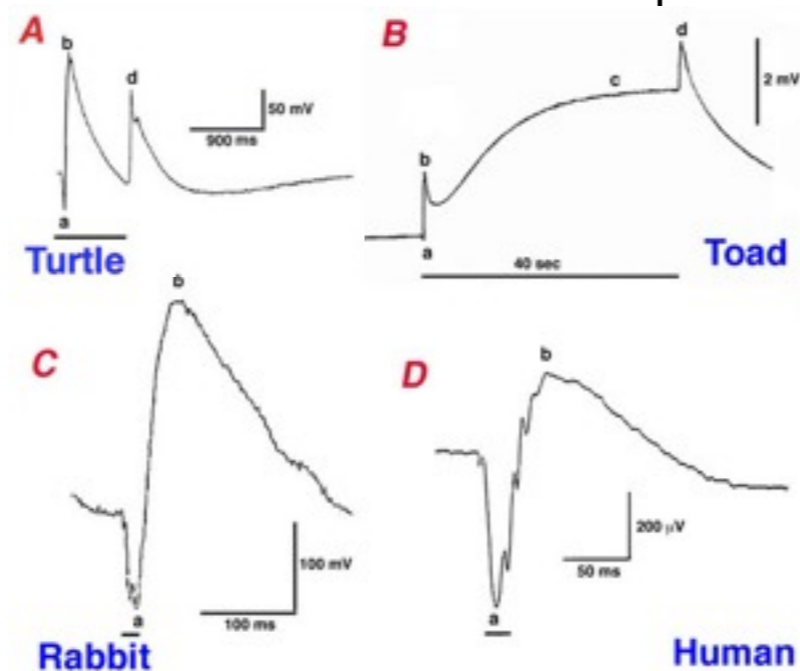

Fig. 1. (A) ERG response of turtle *Pseudemys scripta elegans* elicited by a 500ms light stimulus in order to separate the a-wave and b-wave from the d-wave. (B) The ERG of the bullfrog elicited by a long (40sec) light stimulus in order to show the c-wave in addition to the a-, b- and d-waves (Oakley, 1977). (C) The ERG response of a rabbit to a flash (20  $\mu$ s) flash of white light. (D) The ERG response from a

# Historical view

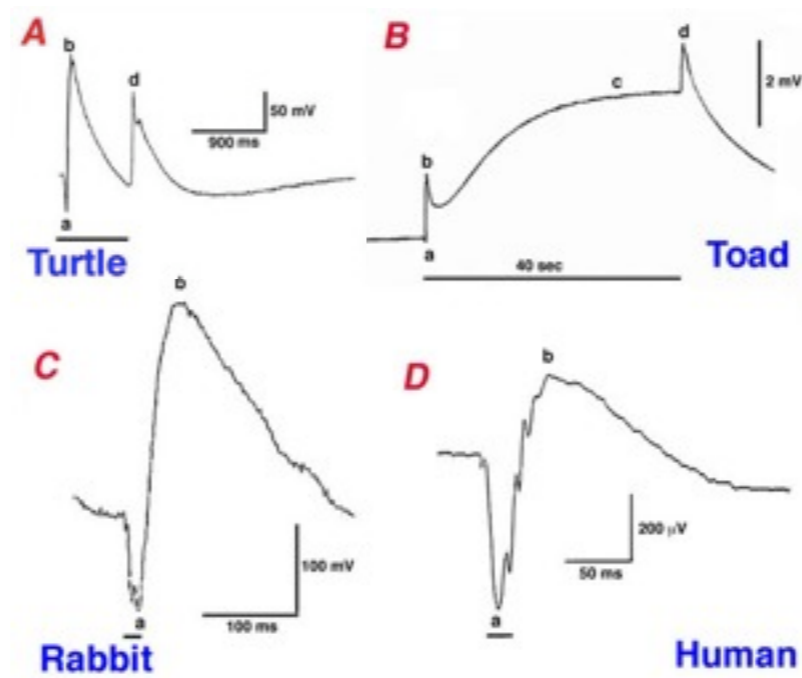
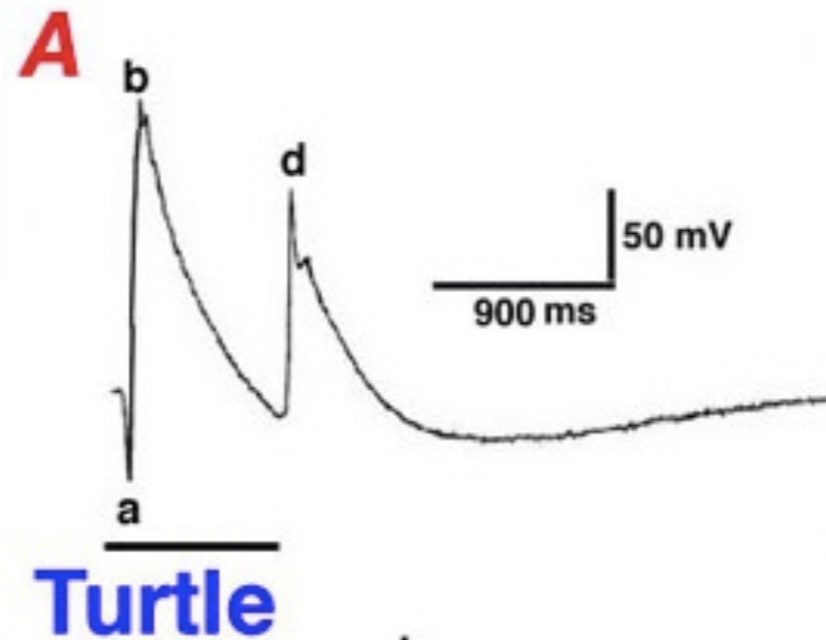

Fig. 1. (A) ERG response of turtle *Pseudemys scripta elegans* elicited by a 500ms light stimulus in order to separate the a-wave and b-wave from the d-wave. (B) The ERG of the bullfrog elicited by a long (40sec) light stimulus in order to show the c-wave in addition to the a-, b- and d-waves (Oakley, 1977). (C) The ERG response of a rabbit to a flash (20  $\mu$ s) flash of white light. (D) The ERG response from a

# Responses to bright light stimuli applied in the dark-adapted state.



- ERG signal elicited by a 900ms step of light.
- Shows an a-wave and b-wave complex separated from the d-wave which is generated at the stimulus falling edge.

# Responses to bright light stimuli applied in the dark-adapted state.

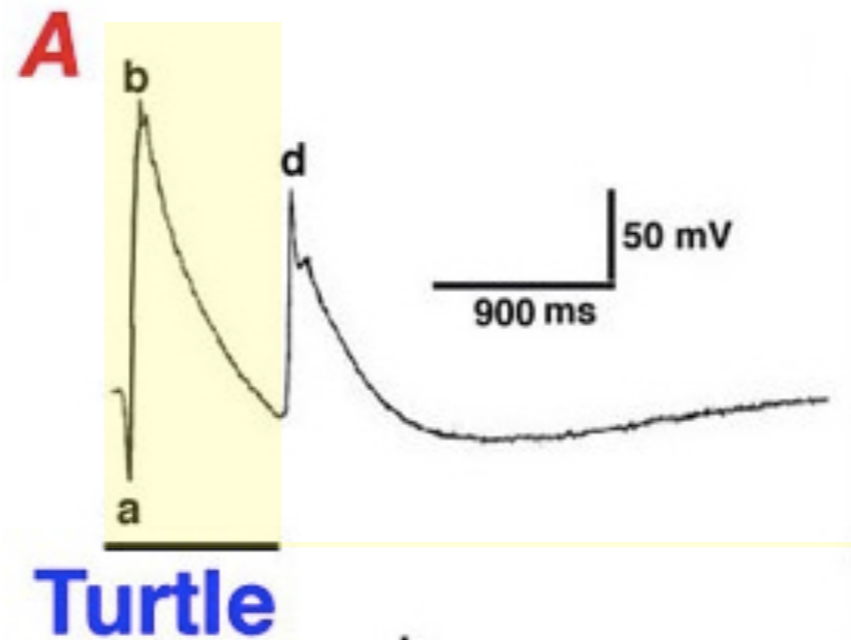

- ERG signal elicited by a 900ms step of light.
- Shows an a-wave and b-wave complex separated from the d-wave which is generated at the stimulus falling edge.

# Responses to bright light stimuli applied in the dark-adapted state.

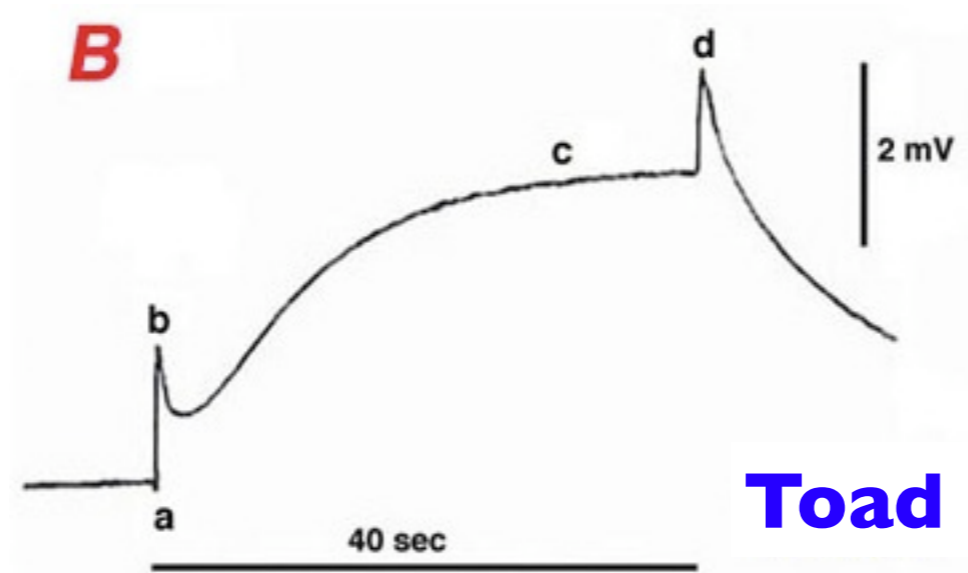

**Toad / Bullfrog**

- Bright light stimulus of 40s.
- The a-wave and b-wave are followed by the slow corneal-positive c-wave.
- At the stimulation falling edge, a d-wave develops.

# Responses to bright light stimuli applied in the dark-adapted state.

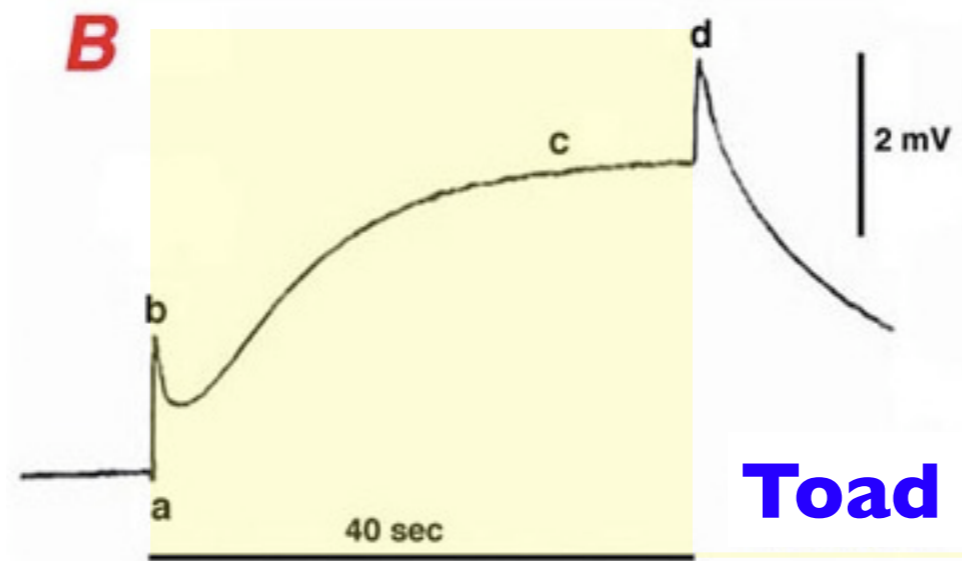

**Toad / Bullfrog**

- Bright light stimulus of 40s.
- The a-wave and b-wave are followed by the slow corneal-positive c-wave.
- At the stimulation falling edge, a d-wave develops.



# Responses to bright light stimuli applied in the dark-adapted state.

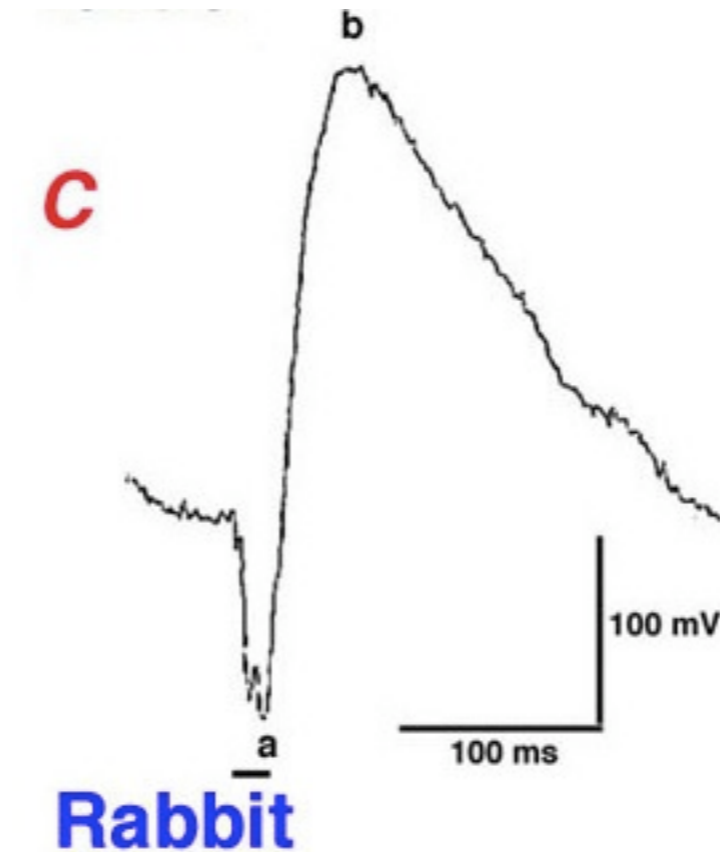

- Fast 20ms bright flash
- (Therefore) Only the a-wave and b-wave are seen

# Responses to bright light stimuli applied in the dark-adapted state.

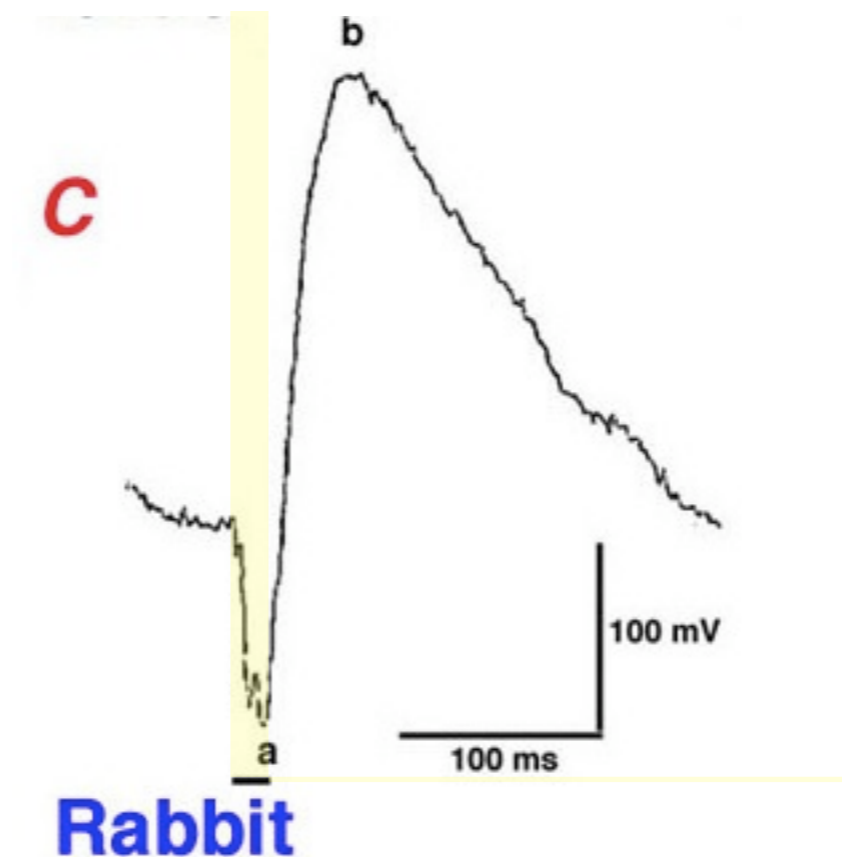

- Fast 20ms bright flash
- (Therefore) Only the a-wave and b-wave are seen

# Responses to bright light stimuli applied in the dark-adapted state.

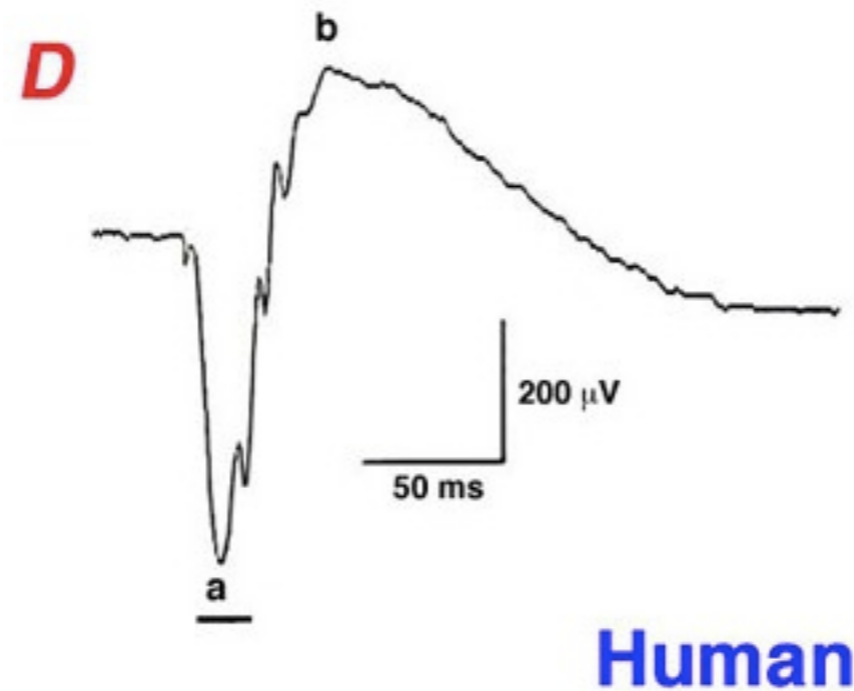

- Fast 20ms bright flash
- (Therefore) Only the a-wave and b-wave are seen.
- Fast oscillations can also be seen on the rising edge of the b-wave.

# Responses to bright light stimuli applied in the dark-adapted state.

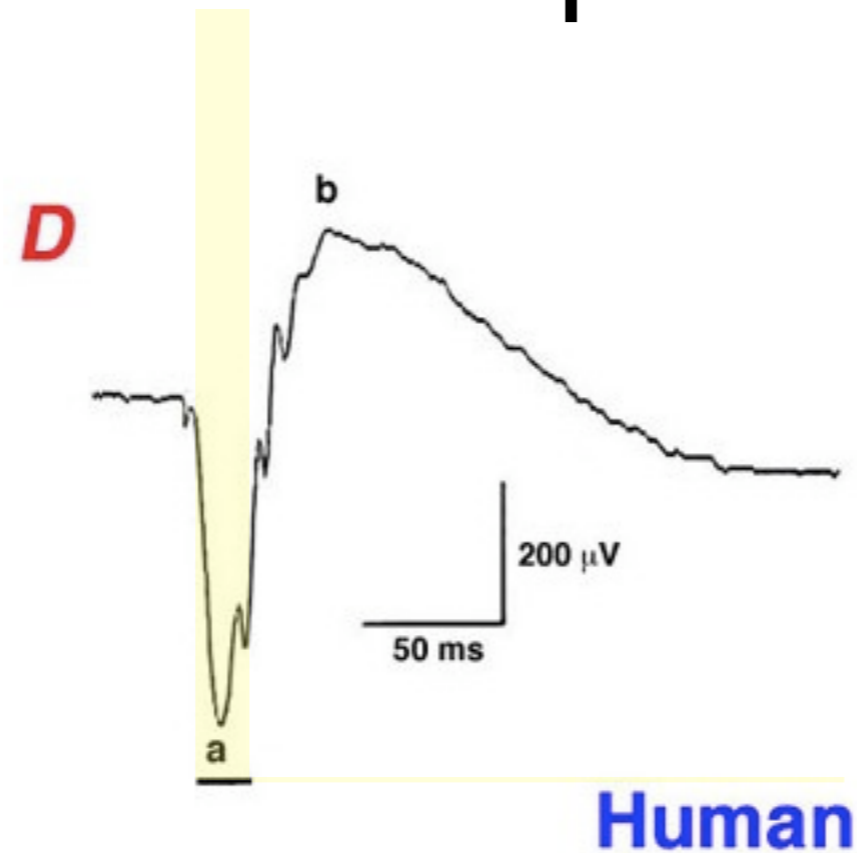

- Fast 20ms bright flash
- (Therefore) Only the a-wave and b-wave are seen.
- Fast oscillations can also be seen on the rising edge of the b-wave.

# Responses to bright light stimuli applied in the dark-adapted state.

These ERGs, in the different species, clearly differ in amplitude and pattern.

Some of this variability is due to species differences, particularly, the relative densities of rods and cones.

The recorded waveform is affected by technical factors such as:

- duration and intensity of photo-stimulation
- method of recording.

Nevertheless, ERG responses of turtle, bullfrog, rabbit and human, in addition to those recorded from other vertebrate species, are characterized by the basic features of a negative a-wave followed by a positive b-wave.

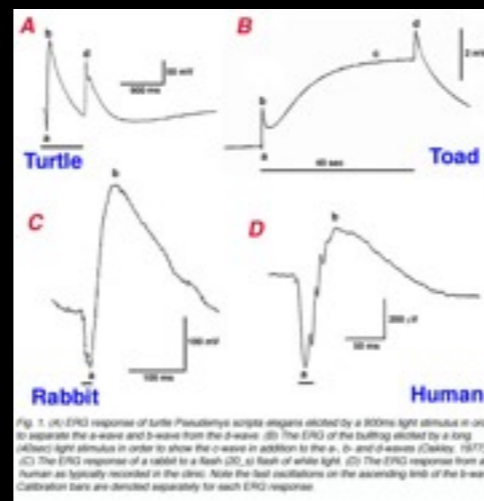

# Historical view

- 1911:
  - The ERG is divided into 3 components: I, II and III.. [*Über die Netzhautströme* / Piper, H. / *Archiv für Physiologie*, 1911 no. 1/2: 85-132][*Relations between the amplitudes of spontaneous saccades and visual responses* / John C. Armington and Marie B. Bloom / *J Opt Soc Am.* 1974 Sep;64(9):1263-71]
    - The interaction between the first two waves I and II results in the formation of the a- and b-waves.
    - Wave III is equivalent to the c-wave.
- 1933:
  - ERG recordings from anesthetized cat using corneal electrodes. [*The components of the retinal action potential in mammals and their relation to the discharge in the optic nerve.* / Granit R. / *J Physiol.* 1933 Feb 8;77(3):207-39 ]
    - Granit observed the gradual removal of the different components as the level of anesthesia was deepened (ether narcosis).
    - He termed the different components in sequence of their disappearance: **P-I**, **P-II** and **P-III**.

# Historical view

- 1933:
  - ERG recordings from anesthetized cat using corneal electrodes. [ *The components of the retinal action potential in mammals and their relation to the discharge in the optic nerve. / Granit R. / J Physiol. 1933 Feb 8;77(3):207-39* ]
    - Granit observed the gradual removal of the different components as the level of anesthesia was deepened (ether narcosis).
    - He termed the different components in sequence of their disappearance: **P-I**, **P-II** and **P-III**.
    - The **P-I** component is a slow cornea-positive wave.
    - **P-II** is also a corneal-positive wave that rises relatively fast to a peak amplitude and then recovers to an intermediate potential while the light stimulus is still on.
    - **P-III** (the most resistant to the level of anesthesia) is a cornea-negative wave that develops faster than the other two and remains as a negative potential for as long as the light stimulus is on.

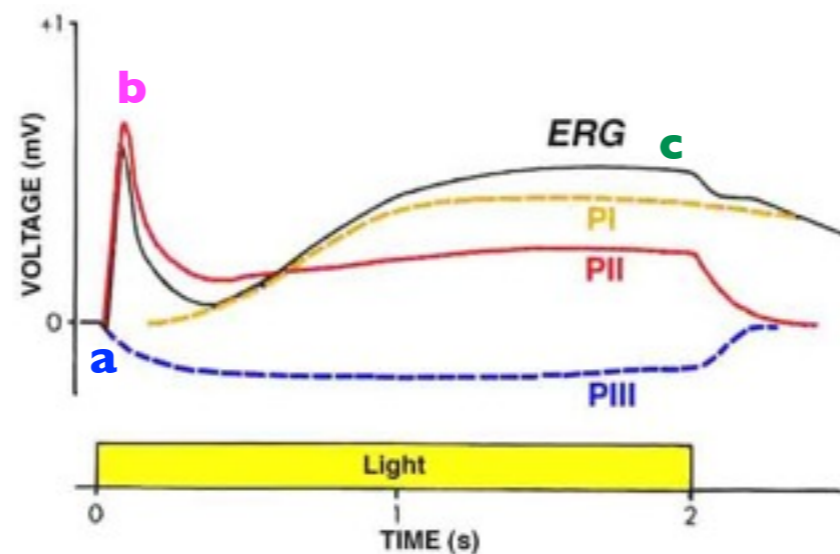

Fig. 2b. The ERG of a cat in response to a 2 sec light stimulus. The components, P-I, P-II and P-III, have been isolated by deepening the state of anesthesia (Granit, 1933).

# Historical view

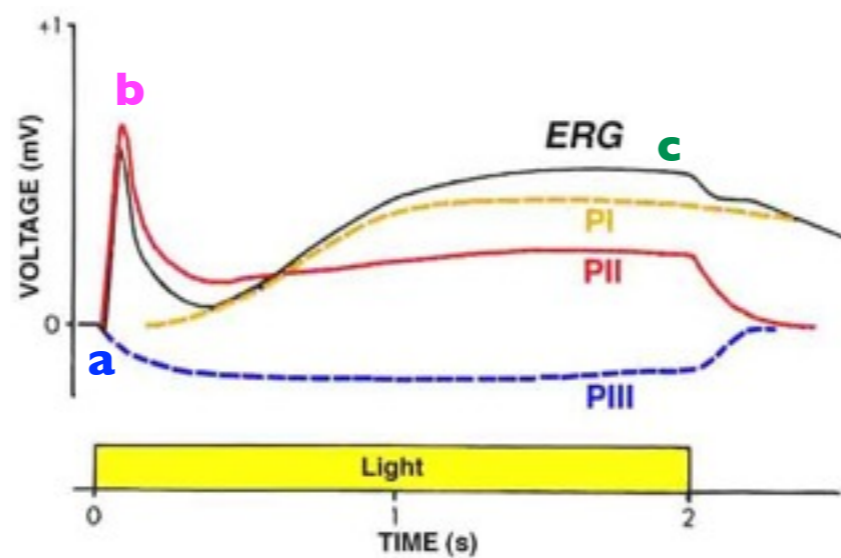

Fig. 2b. The ERG of a cat in response to a 2 sec light stimulus. The components, P-I, P-II and P-III, have been isolated by deepening the state of anesthesia (Granit, 1933).



# P-I, P-II, P-III to a, b c

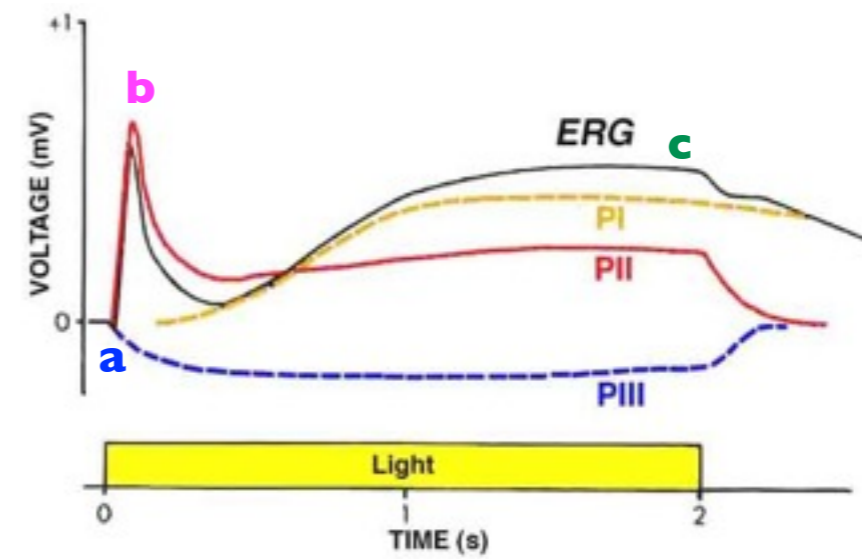

Fig. 2b. The ERG of a cat in response to a 2 sec light stimulus. The components, P-I, P-II and P-III, have been isolated by deepening the state of anesthesia (Granit, 1933).

# P-I, P-II, P-III to a, b c

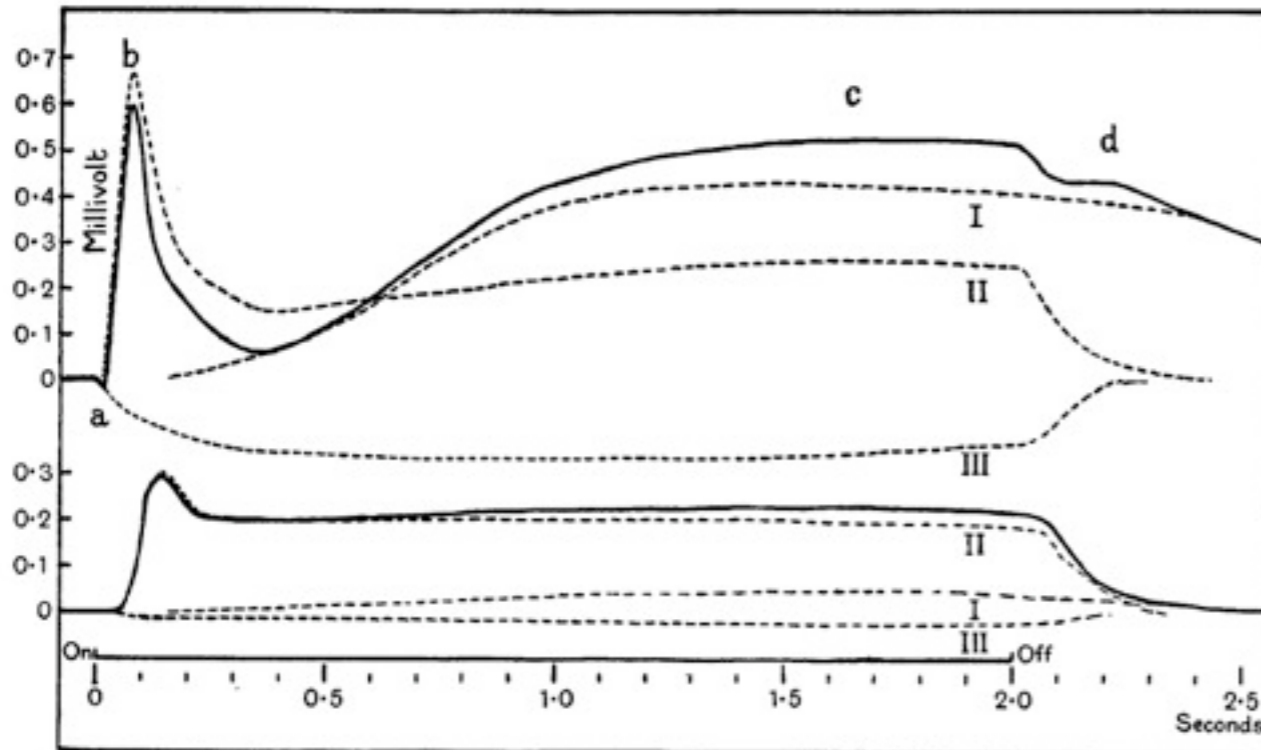

Fig. 8. Analysis of composite retinal action potential at two intensities, 14 ml, and 0.14 ml, and area of 1661 sq. mm. viewed at a distance of 70 mm. Components: broken lines. Composite curve drawn in full. The *a*-wave is broadened slightly out of scale to show its derivation more clearly.

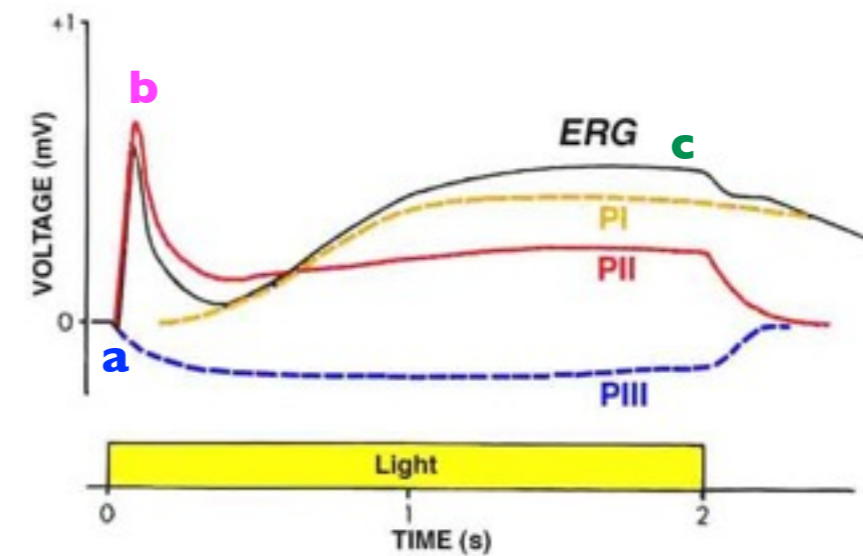

Fig. 2b. The ERG of a cat in response to a 2 sec light stimulus. The components, P-I, P-II and P-III, have been isolated by deepening the state of anesthesia (Granit, 1933).

In summary, we see that

- the negative **a-wave** is the falling edge of the negative **P-III** component;
- the positive **b-wave** reflects the summation of **P-II** and **P-III**
- while the slow **c-wave** follows **P-I** which is offset by the summation of **P-II** and **P-III**.

# The origin of the major ERG waves.

## The c-wave

- The c-wave is known to originate in the pigment epithelium [ *The origin of the electroretinogram.* / Noell WK / *Am J Ophthalmol.* 1954 Jul;38(1:2):78-90.].
- This interpretation of the c-wave origin was proven directly when intracellular recordings were made from pigment epithelial cells [ *Intracellular responses to light from cat pigment epithelium: origin of the electroretinogram c-wave* / Steinberg RH, Schmidt R, Brown KT / *Nature.* 1970 Aug 15;227(5259):728-30.].
- The potential changes that were recorded from these cells in response to light stimuli were identical in shape and temporal properties to the ERG c-wave.
- When the retina was separated from the RPE, the ERG response contained normal a- and b-wave, but c-wave disappeared.

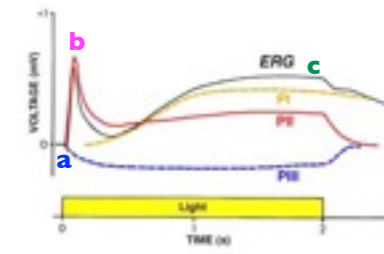
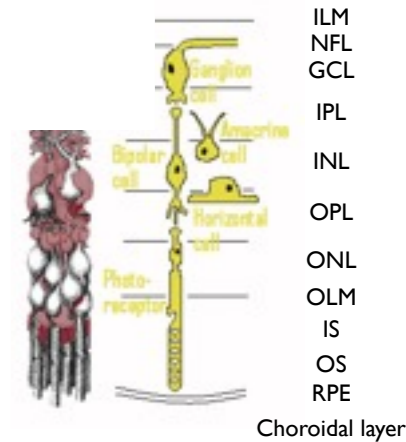
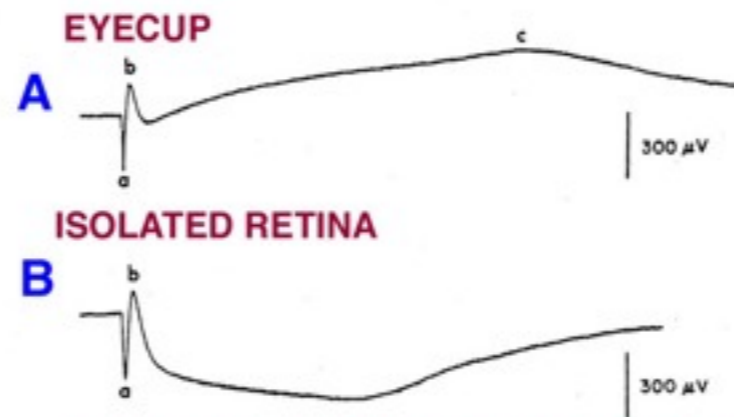

Fig. 26. The ERG of a skate in response to a flash of light stimulus. The components P1, P1' and P1E have been isolated by measuring the area of summation (Cohen, 1965).



ERG recording from the skate eyecup, Pepperberg et al., 1978

# The origin of the major ERG waves.

## The c-wave

- The c-wave is known to originate in the pigment epithelium [ *The origin of the electroretinogram.* / Noell WK / *Am J Ophthalmol.* 1954 Jul;38(1:2):78-90.].
- This interpretation of the c-wave origin was proven directly when intracellular recordings were made from pigment epithelial cells [ *Intracellular responses to light from cat pigment epithelium: origin of the electroretinogram c-wave* / Steinberg RH, Schmidt R, Brown KT / *Nature.* 1970 Aug 15;227(5259):728-30.].
- The potential changes that were recorded from these cells in response to light stimuli were identical in shape and temporal properties to the ERG c-wave.
- When the retina was separated from the RPE, the ERG response contained normal a- and b-wave, but c-wave disappeared.

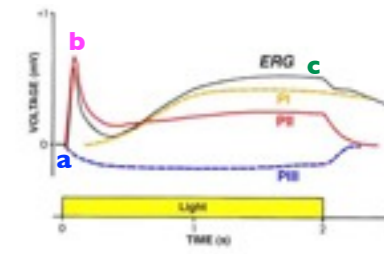
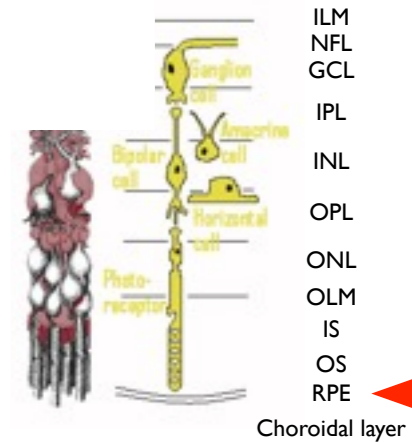
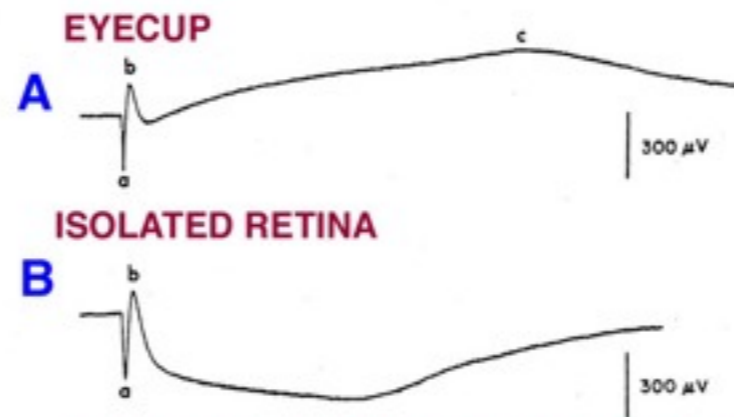

Fig. 26. The ERG of a skate in response to a flash light stimulus. The components P1, P1 and P1b have been isolated by measuring the area of summation (Cohen, 1955).



ERG recording from the skate eyecup, Pepperberg et al., 1978

# The origin of the major ERG waves.

## The c-wave

- The pigment epithelium cells are functionally asymmetrical cells with their basal membrane (toward the choroid) less permeable to potassium ions than the apical membrane (retinal side).
- This asymmetry causes a constant potential difference between the retina and the choroid with the retinal side positive relative to the choroidal side (The standing potential of the eye).

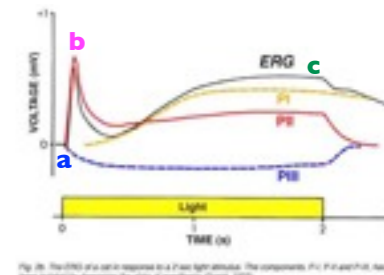
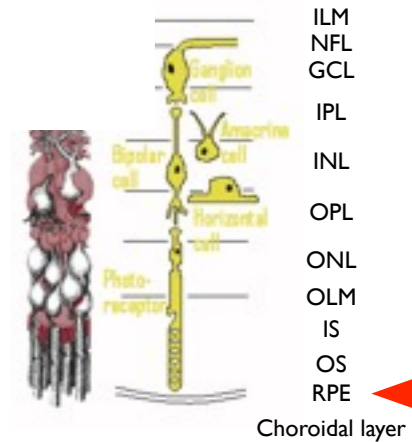
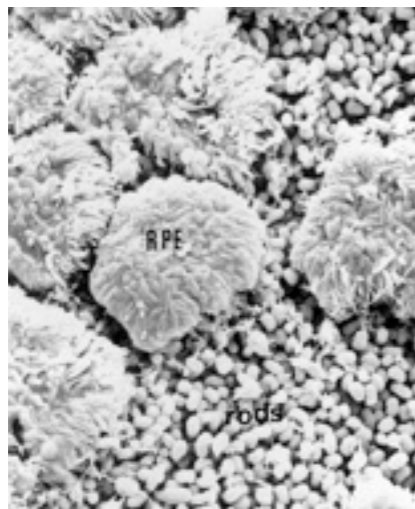
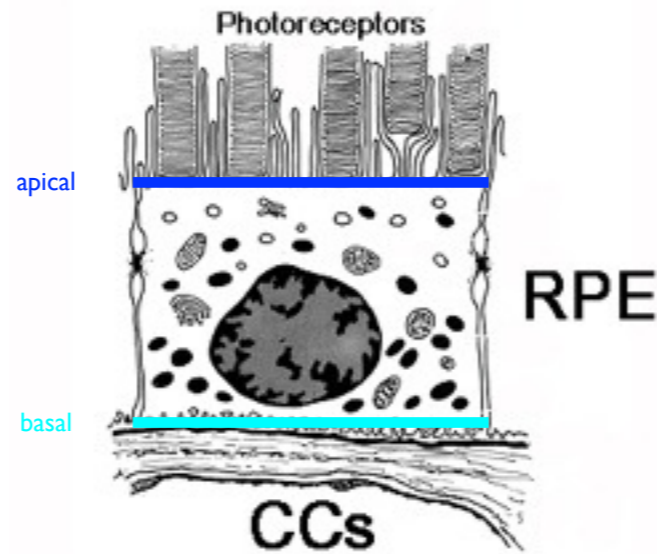

Fig. 26. The ERG of a cat is composed of a P wave (light stimulus). The components P1, P2 and P3 are shown. Adapted from the work of Marmor and Marmor (1982).



courtesy William S. Stark (<http://starklab.slu.edu/>)



Adapted from Clark, 1986

in the dark:  $V_{ap} > V_{ba}$

mean  $V_{ap}$   
 $-85 \pm 7\text{mV}$   
 $n = 18$  cells

mean  $V_{ba}$   
 $-69 \pm 8\text{mV}$   
 $n = 18$  cells

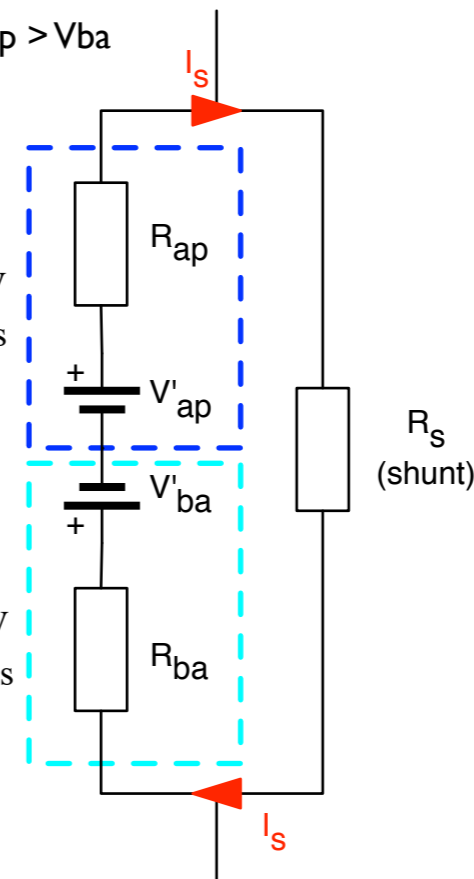

mean TEP  
 $19 \pm 6\text{mV}$   
 $n = 66$

Griff et al., 1984

# The origin of the major ERG waves.

## The c-wave

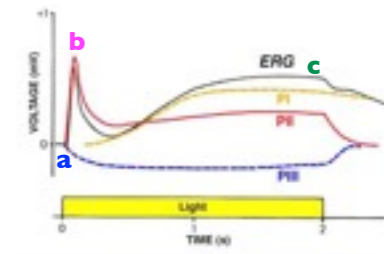
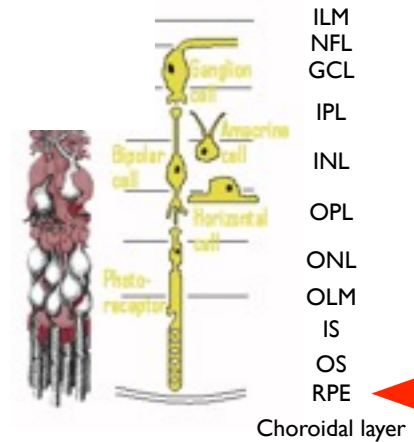
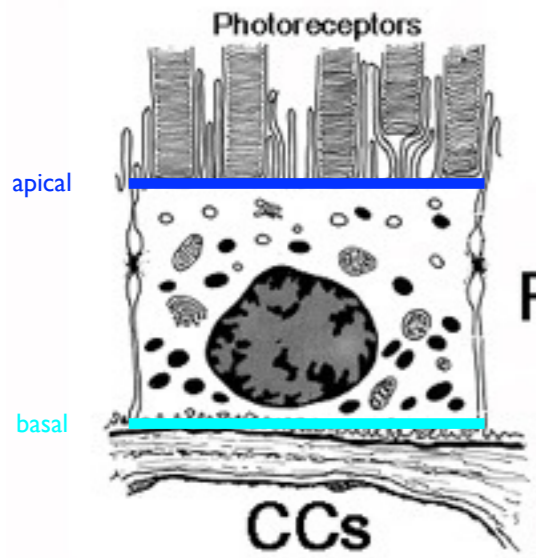
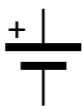

Fig. 26. The ERG of a cat in response to a 2 flash light stimulus. The components PI, PII and PIII have been identified by measuring the state of adaptation (Green, 1955).



K<sup>+</sup>



mean TEP  
19 ± 6mV  
n = 66

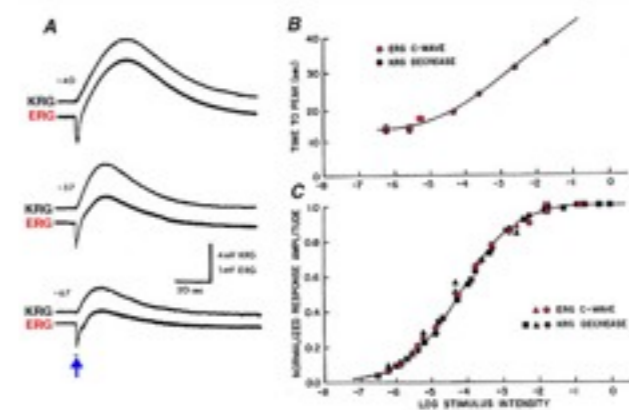

Fig. 5. (A) Simultaneous recordings with double-barrel microelectrode of the ERG and the changes in the KRG from the distal retina of the frog. The KRG responses were inverted in polarity to compare with the ERG c-wave. Three different intensities of the light stimulus were applied. (B) Comparing time-to-peak (upper panel) and peak amplitude (lower panel) of the ERG c-wave and the KRG (Oakley and Green, 1976).

Adapted from Clark, 1986

# The origin of the major ERG waves.

## The c-wave

- Measurements with potassium-sensitive microelectrode in the photoreceptor layer shows a light-induced decrease in the extracellular concentration of potassium ions, due to light-induced electrical activity in the photoreceptors.
- The reduction in the extracellular concentration of potassium ions near the apical membrane of the pigment epithelial cells is expressed as an increase in the trans-epithelial potential with the retinal side becoming more positive relative to the choroidal side.
- This is the ERG c-wave when recorded with a corneal electrode (Oakley and Green, 1976; Oakley, 1977)

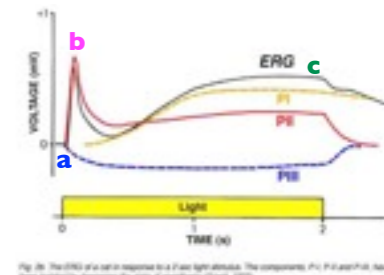
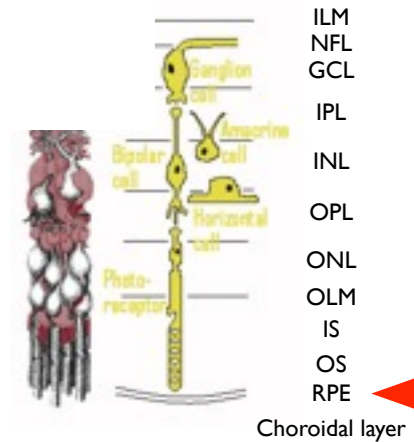
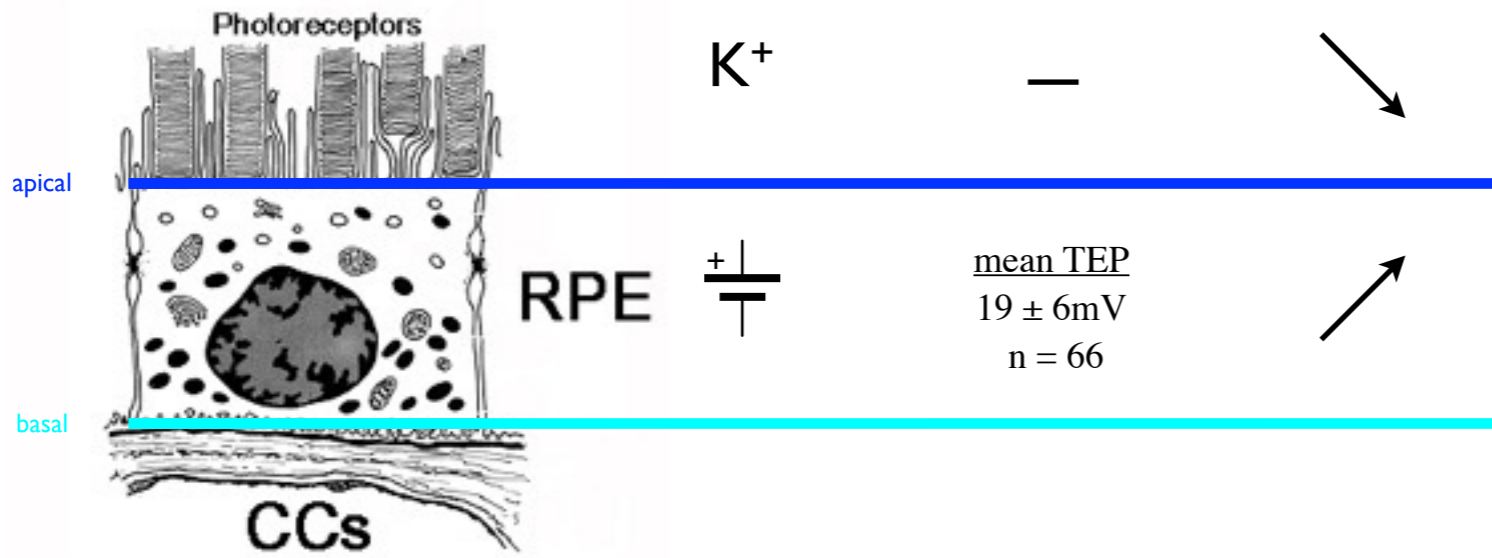
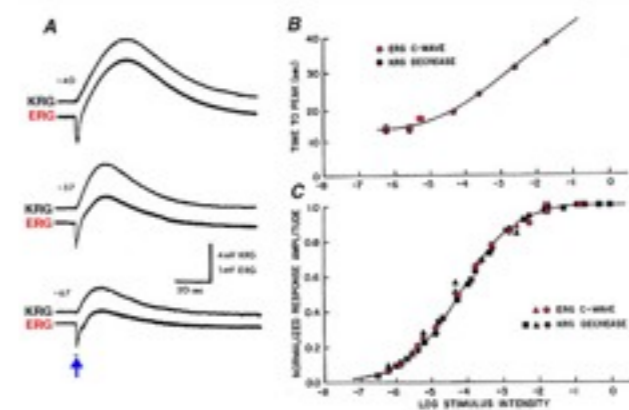

Fig. 26. The ERG of a cat in response to a 2 sec light stimulus. The components PI, PII and PIII have been identified by measuring the slope of stimulation (Green, 1955).



Adapted from Clark, 1986



To simplify the comparison, the KRG responses are inverted, thus a positive deflection in this figure means a reduction in extracellular concentration of potassium ions.

# The origin of the major ERG waves.

## The c-wave

Although the c-wave originates from the pigment epithelium, it depends upon the integrity of the photoreceptors, because light absorption in the photoreceptors triggers the chain of events leading to the decrease in extracellular concentration of potassium ions.

Therefore, the ERG c-wave can be used to assess the functional integrity of the photoreceptors, the pigment epithelial cells and the interactions between them.

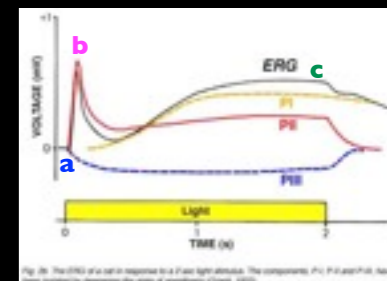
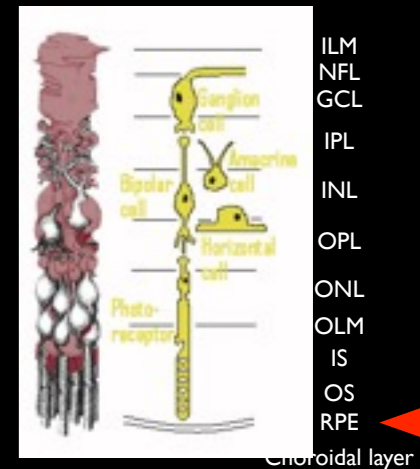



# The origin of the major ERG waves.

## The a-wave

- The ERG a-wave is the leading part of Granit's P-III component.
- The most important information on the origin of these waves was obtained from ERG recordings with intra-retinal microelectrodes (Tomita, 1950; Brown and Wiesel, 1961a, 1961b; Brown and Murakami, 1964a; Brown, 1968). These studies suggested the photoreceptor layer as the origin of the fast P-III wave.
- Differential recording in the rat retina using two microelectrodes revealed that the a-wave resulted from extracellular radial current.

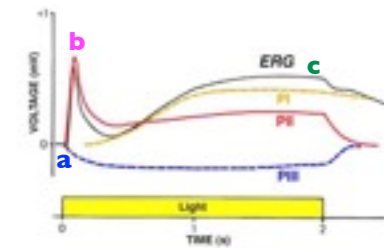
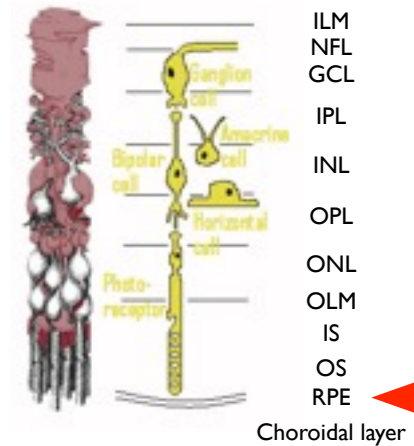
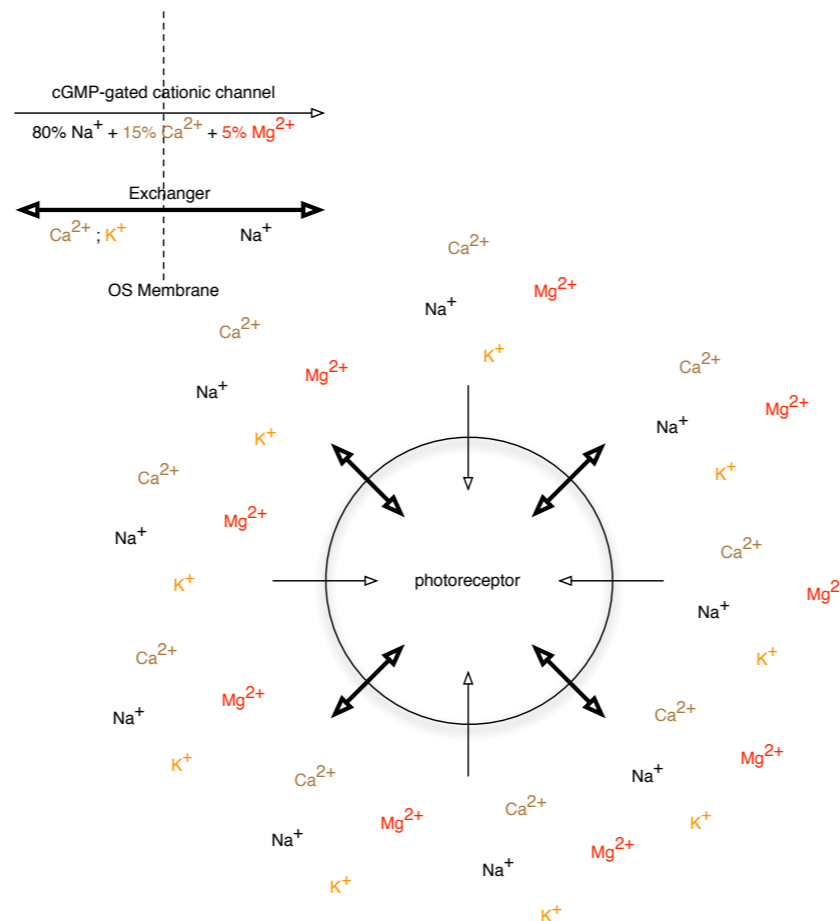

Fig. 26. The ERG of a rat in response to a 2 sec light stimulus. The components PI, PII and PIII have been identified by measuring the state of adaptation. (Green, 1955)



# The origin of the major ERG waves.

## The a-wave

- The ERG a-wave is the leading part of Granit's P-III component.
- The most important information on the origin of these waves was obtained from ERG recordings with intra-retinal microelectrodes (Tomita, 1950; Brown and Wiesel, 1961a, 1961b; Brown and Murakami, 1964a; Brown, 1968). These studies suggested the photoreceptor layer as the origin of the fast P-III wave.
- Differential recording in the rat retina using two microelectrodes revealed that the a-wave resulted from extracellular radial current.

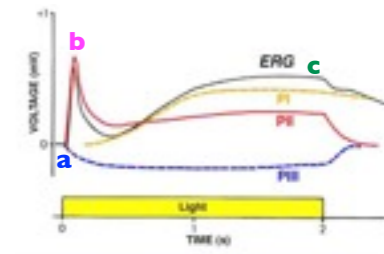
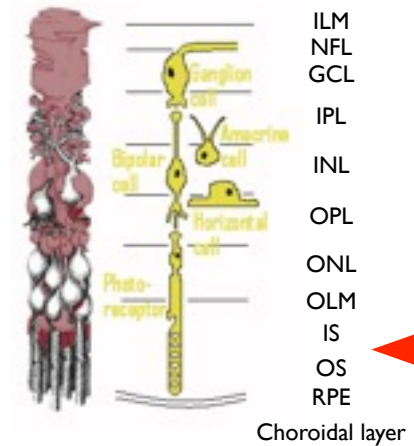
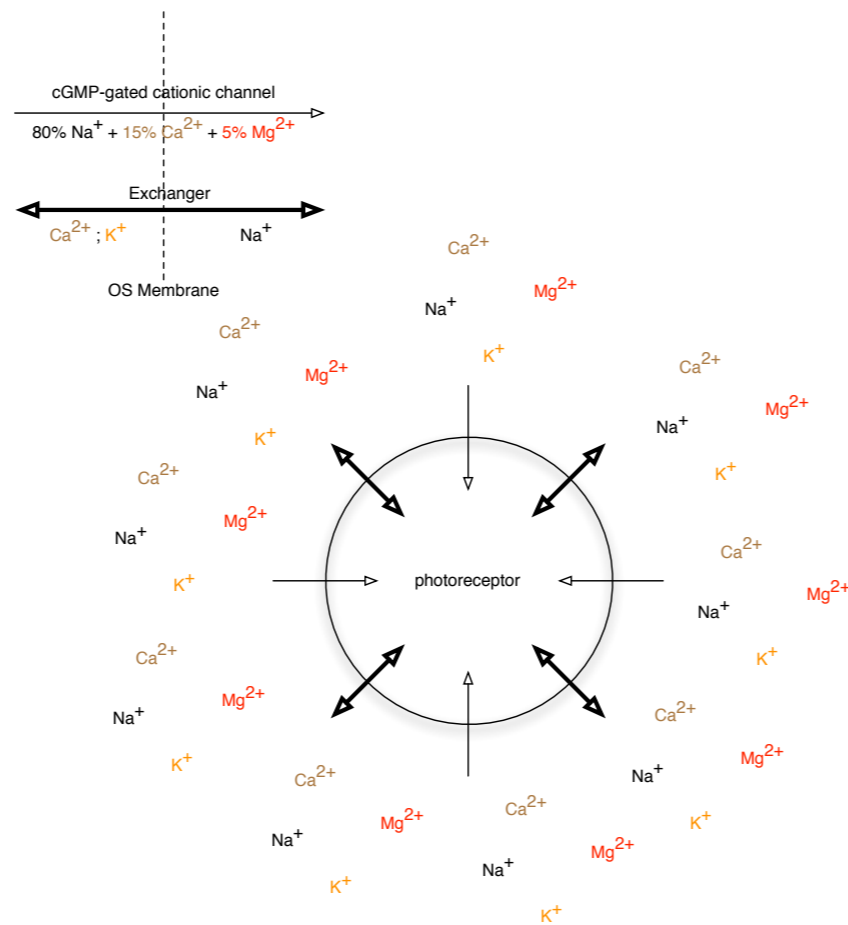

Fig. 26. The ERG of a rat in response to a 2 sec light stimulus. The components P-I, P-II and P-III have been identified by measuring the state of adaptation. (Granit, 1955)



# The origin of the major ERG waves.

## The a-wave

- The ERG a-wave is the leading part of Granit's P-III component.
- The most important information on the origin of these waves was obtained from ERG recordings with intra-retinal microelectrodes (Tomita, 1950; Brown and Wiesel, 1961a, 1961b; Brown and Murakami, 1964a; Brown, 1968). These studies suggested the photoreceptor layer as the origin of the fast P-III wave.
- Differential recording in the rat retina using two microelectrodes revealed that the a-wave resulted from extracellular radial current.

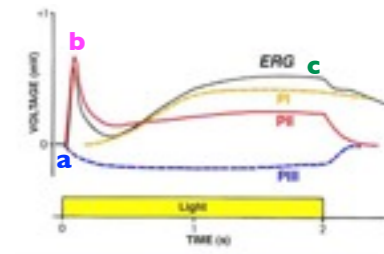
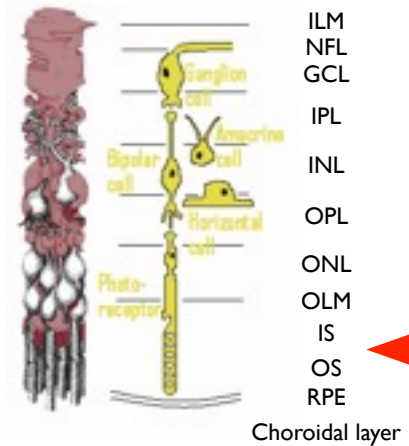
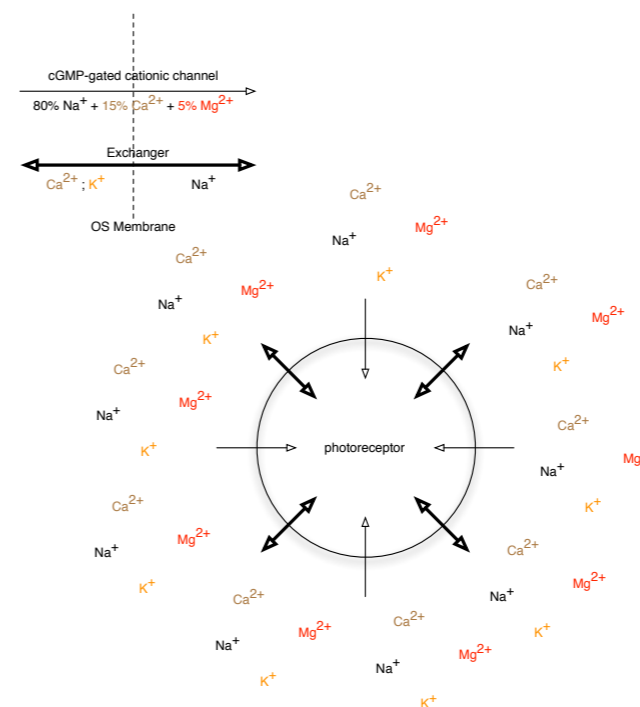

Fig. 26. The ERG of a rat in response to a 2-min light stimulus. The components P1, P2 and P3 have been identified by measuring the ratio of amplitudes (Granit, 1955).



# The origin of the major ERG waves.

## The a-wave

- The ERG a-wave is the leading part of Granit's P-III component.
- The most important information on the origin of these waves was obtained from ERG recordings with intra-retinal microelectrodes (Tomita, 1950; Brown and Wiesel, 1961a, 1961b; Brown and Murakami, 1964a; Brown, 1968). These studies suggested the photoreceptor layer as the origin of the fast P-III wave.
- Differential recording in the rat retina using two microelectrodes revealed that the a-wave resulted from extracellular radial current.
- This is the 'light' current and basically reflects the reduction in the 'dark' currents due to light absorption in the photoreceptor outer segments, and closure of cGMP-gated cationic channels (Penn and Hagins, 1969; Sillman et al., 1969b).

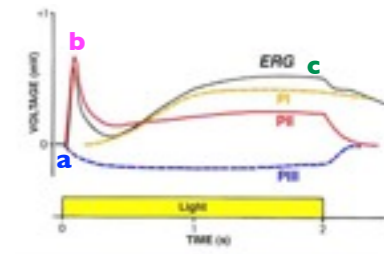
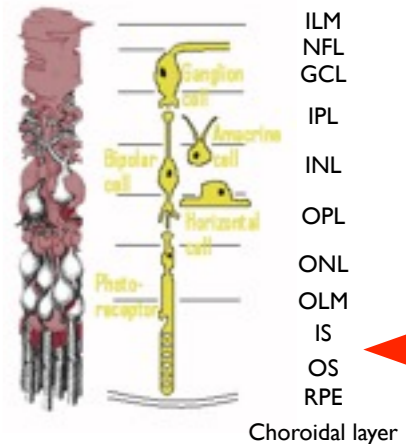
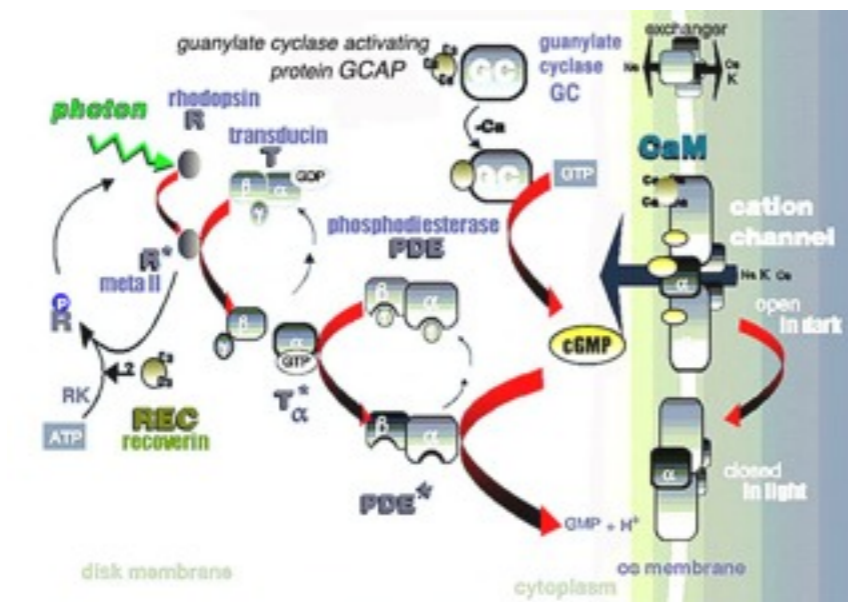
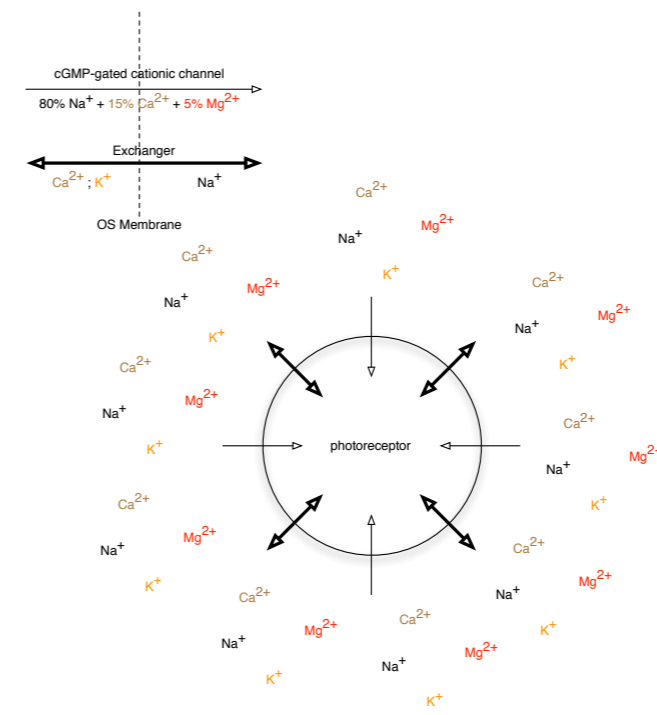

Fig. 26 The ERG of a rat in response to a flash of light. The components P1, P2 and P3 have been identified by measuring the area of individual waves. (1968)



Activation of rhodopsin by photons of light and the phototransduction cascade that results in closing of cGMP gated channels in the outer segment membrane. Courtesy of Wolfgang Baehr.



# The origin of the major ERG waves.

## The a-wave

- The ERG a-wave is the leading part of Granit's P-III component.
- The most important information on the origin of these waves was obtained from ERG recordings with intra-retinal microelectrodes (Tomita, 1950; Brown and Wiesel, 1961a, 1961b; Brown and Murakami, 1964a; Brown, 1968). These studies suggested the photoreceptor layer as the origin of the fast P-III wave.
- Differential recording in the rat retina using two microelectrodes revealed that the a-wave resulted from extracellular radial current.
- This is the 'light' current and basically reflects the reduction in the 'dark' currents due to light absorption in the photoreceptor outer segments, and closure of cGMP-gated cationic channels (Penn and Hagins, 1969; Sillman et al., 1969b).
- It has now been shown that P-III can be divided into a further two components (Murakami and Kaneko, 1966; Sillman et al., 1969a):
  - a fast P-III and
  - a slow P-III

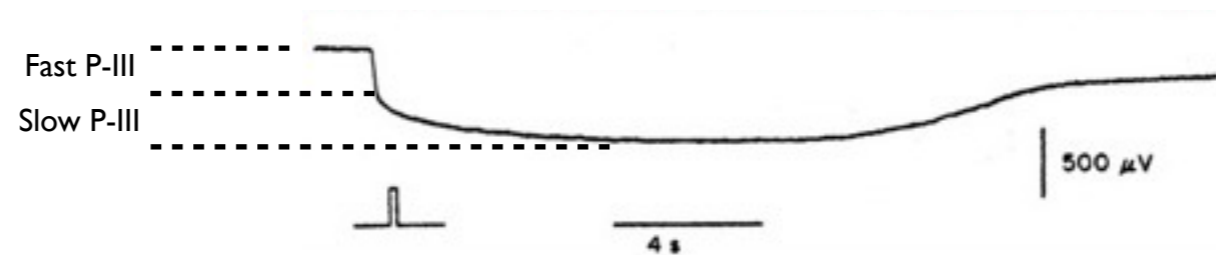

- The slow component of the P-III cannot be identified in a regular ERG response due to the large amplitude positive P-I wave.

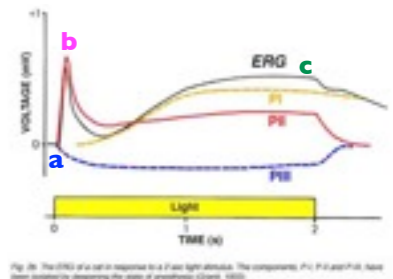
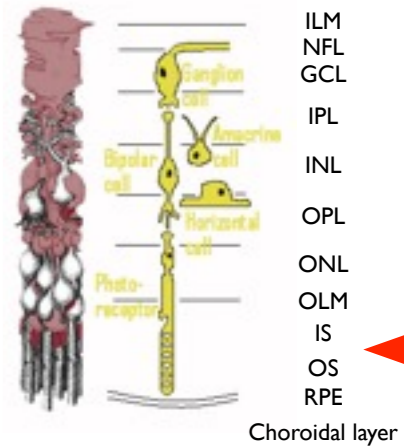

Fig. 20. The ERG of a rat in response to a flash of light. The components P-I, P-II, P-III, P-IV, and P-V are shown. Adapted by permission from the work of Granit (1966).

# The origin of the major ERG waves.

## The a-wave

- By separating the retina from the pigment epithelium, P-I can be eliminated.
- By exposing the retina to drugs, such as aspartic acid, that block synaptic transmission from the photoreceptors to the neurons in the inner nuclear layer, P-II can be eliminated.
- Thus the P-III component can be isolated and studied (Witkovsky et al., 1975).

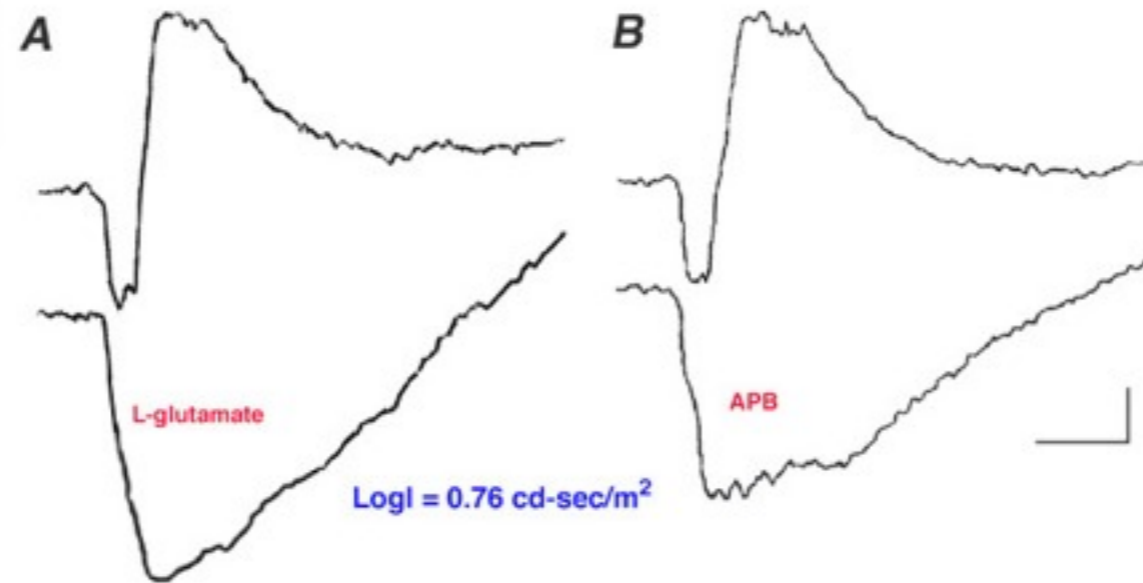
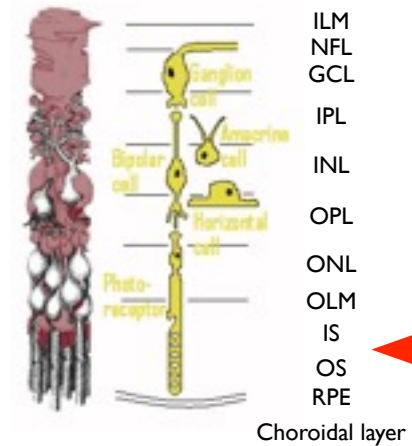

Fig. 6. Elimination of the ERG b-wave (P-II) in rabbits by intravitreal injection of L-glutamate (A) or 2-amino-phosphonobutyric acid (APB) (B). The experimental drug was injected into the right eye (lower trace) and saline into the left eye (upper trace) as a control. In both experiments, the drugs successfully eliminated P-II thus, revealing the entire time course of the P-III component.

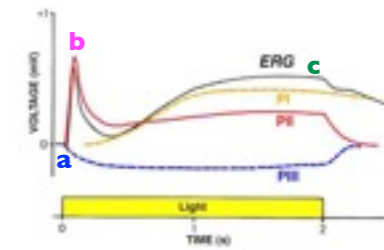
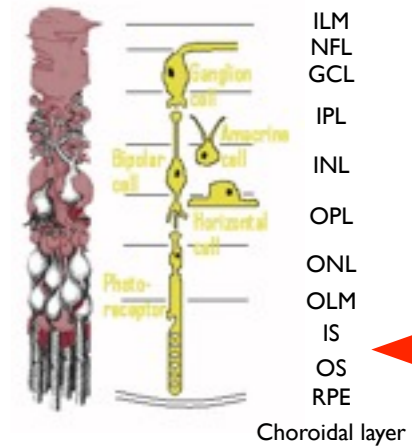

Fig. 26. The ERG of a rabbit in response to a flash of light stimulus. The components P-I, P-II and P-III have been identified by measuring the slope of stimulation (Green, 1955).

# The origin of the major ERG waves.

## The a-wave



### ... and more

- Measurements of the extracellular concentration of potassium ions and of the isolated P-III component of the ERG at different retinal depths reveal the involvement of retinal glial (Müller) cells in the generation of the slow P-III.
- The Müller cells are highly permeable to potassium ions. Therefore, the reduction in the extracellular concentration of potassium ions in the photoreceptor layer, due to light absorption in the photoreceptors, elicits changes in the trans-membrane potential of the Müller cells and is expressed as the slow P-III component of the ERG.

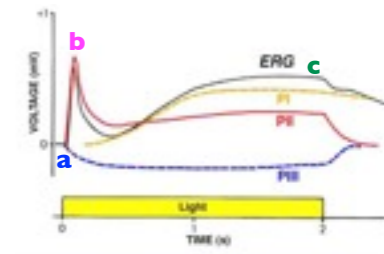
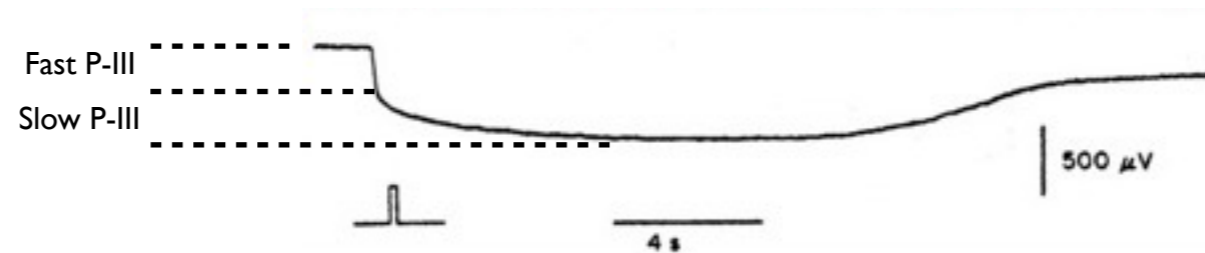
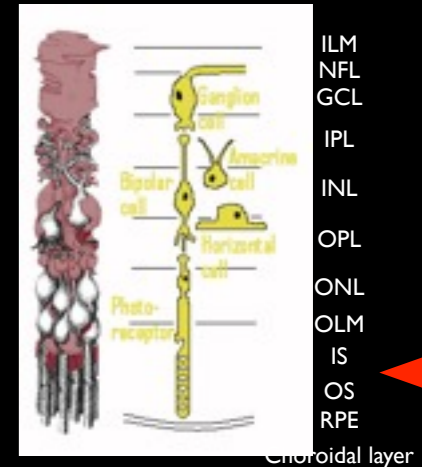

Fig. 26 The ERG of a cat in response to a flash of light. The components P-III, P-III and P-III have been identified by measuring the effect of amiloride (Grazzini, 1982).



# The origin of the major ERG waves.

## The a-wave



- **The ERG a-wave is the leading part of Granit's P-III component.**
- **Numerous studies indicate that the fast P-III component of the ERG reflects light-induced activity of the photoreceptors.**
- **The slow component of the P-III cannot be identified in a regular ERG response due to the large amplitude positive P-I wave.**

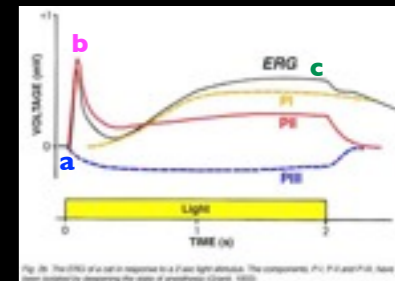

Fig. 20. The ERG of a cat in response to a flash of light. The components P-I, P-II, P-III, and P-IV are indicated by the letters a, b, c, and d, respectively. (From Granit, 1955.)



# The origin of the major ERG waves.

## The b-wave

- The inner retina is involved in the production of the b-wave.

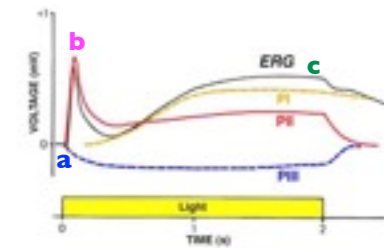
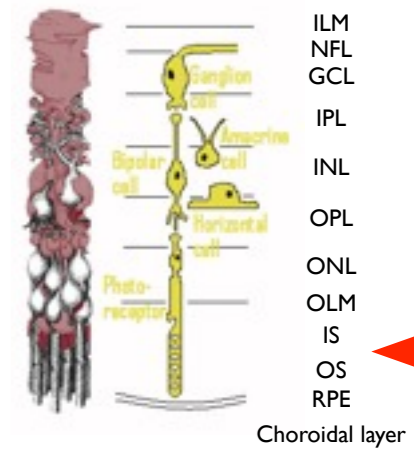

Fig. 26 The ERG of an eye in response to a flash of light. The components P1, P2 and P3 have been identified by measuring the area of stimulation (Green, 1982).



# The origin of the major ERG waves.

## The b-wave

- The inner retina is involved in the production of the b-wave.

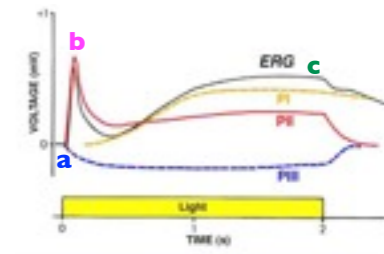
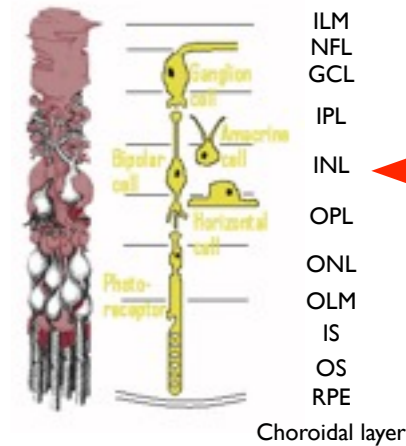

Fig. 26. The ERG of a cat in response to a flash of light. The components P-I, P-II and P-III have been isolated by measuring the state of adaptation. (Green, 1955)

Blocking synaptic transmission from the receptors to second order retinal neurons by saturating the post-synaptic receptors with L-aspartate or L-glutamate, eliminates the ERG b-wave and isolates the P-III component.

1954

1962

The b-wave is also eliminated when the blood flow through the central retinal artery is blocked either intentionally in laboratory animals (Noell, 1954; Brown and Watanabe, 1962), or in human patients (Nilsson, 1971).



# The origin of the major ERG waves.

## The b-wave

- Faber reported that a **sink** for the b-wave was in the **distal** part of the retina, most probably in the outer plexiform layer, while the **source** was distributed **proximally and distally to the sink**.
- The only retinal elements that have a spatial distribution similar to the b-wave sources and sinks are the Müller glial cells.

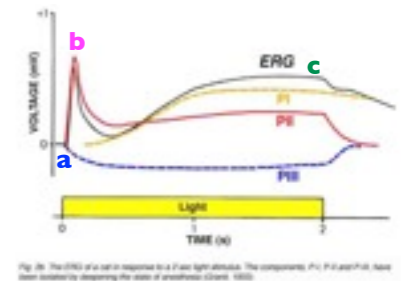
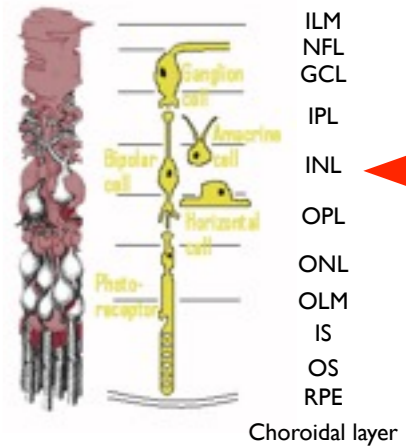
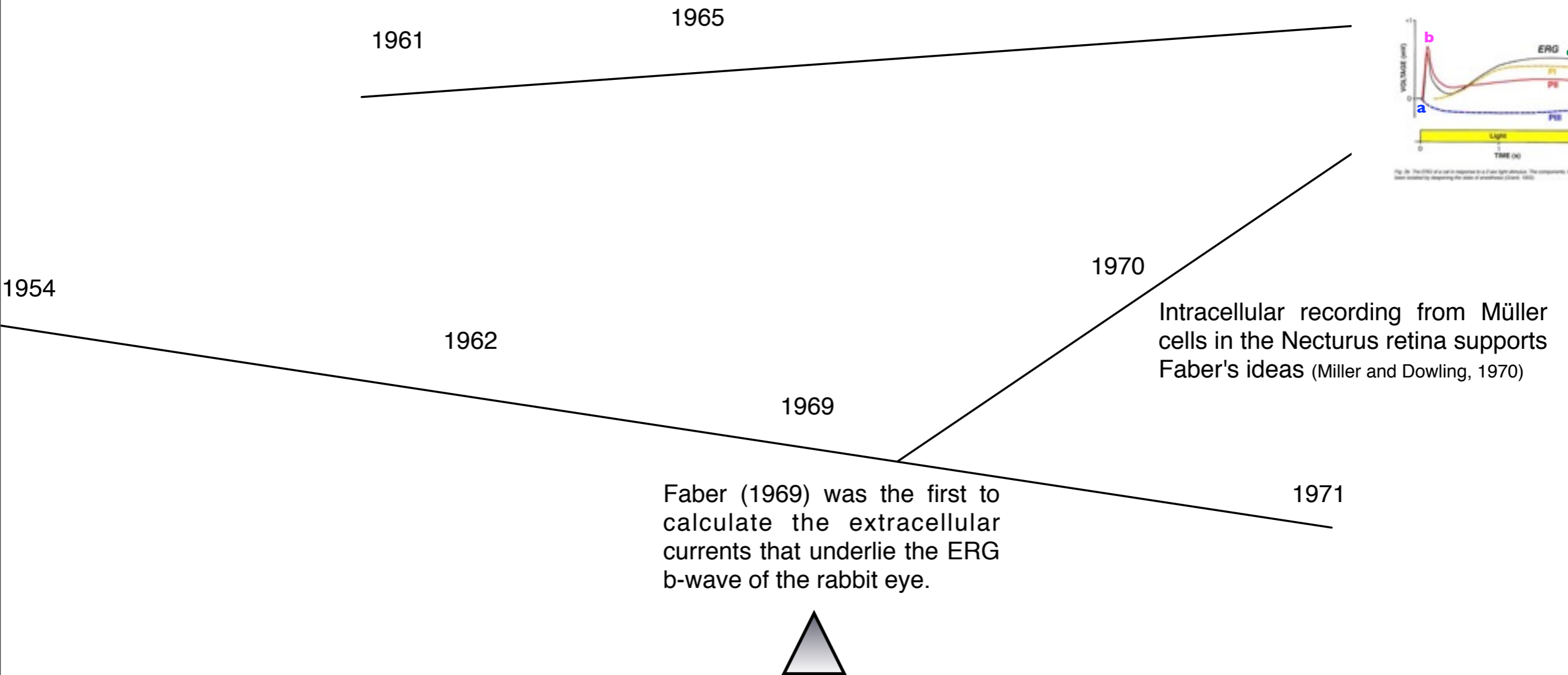

Fig. 26 The ERG of a cat in response to a flash of light stimulus. The components P1, P2 and P3 have been identified by measuring the area of summation (Grazia, 1955).



# The origin of the major ERG waves.

## The b-wave

- The slow depolarizing response of Müller cells to a light stimulus followed a **temporal** pattern, similar to that of the ERG b-wave recorded from the same retina.
- Furthermore, the **amplitude**-stimulus intensity relationship was similar for the Müller cell photoresponses and the ERG b-wave.
- Based on these observations, Miller and Dowling (1970) suggested that depolarization of the Müller cell membrane in the distal retina resulted in extracellular currents that were expressed as the b-wave.
- A change in the extracellular concentration of ions that permeate through the Müller cells' membrane may cause a change in membrane potential.

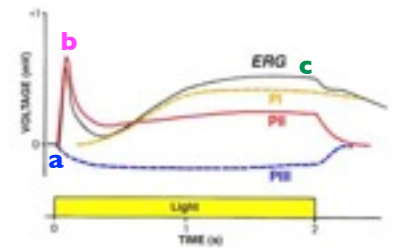
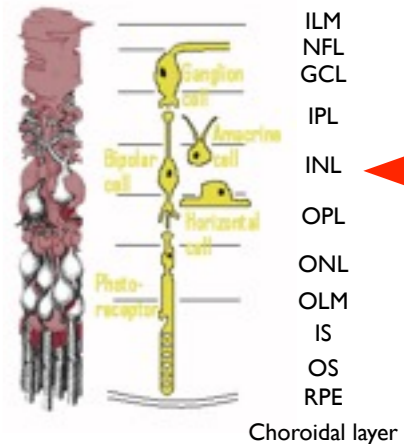

Fig. 26. The ERG of a cat in response to a flash of light stimulus. The components P1, P1 and P1b have been identified by measuring the area of stimulation (Cohen, 1985).

1965

1980

1973

The most effective  
are potassium ions  
(Miller, 1973)

1970

Intracellular recording from Müller  
cells in the Necturus retina supports  
Faber's ideas (Miller and Dowling, 1970)

1969



# The origin of the major ERG waves.

## The b-wave

- Since first proposed, this idea has been tested by many investigators using intracellular recordings from Müller cells, measurements of extracellular concentrations of potassium and recording the ERG at different retinal depths.
- Studies were done in mudpuppy (Karwoski and Proenza, 1980; Karwoski et al., 1985), frog (Newman, 1980; Newman and Odette, 1984; Newman, 1985), fish (Kline et al., 1978, 1985), rabbit (Dick et al., 1985; Karwoski and Xu, 1999), cat (Brown and Wiesel, 1961a, 1961b; Arden and Brown, 1965) and monkey (Heynen and van Norren, 1985a, 1985b).
- These and other studies reported a light-induced increase in extracellular potassium in the **outer and inner plexiform layers**.
- This increase was thought most likely due to leakage from depolarizing retinal neurons.

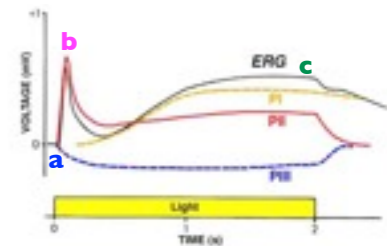
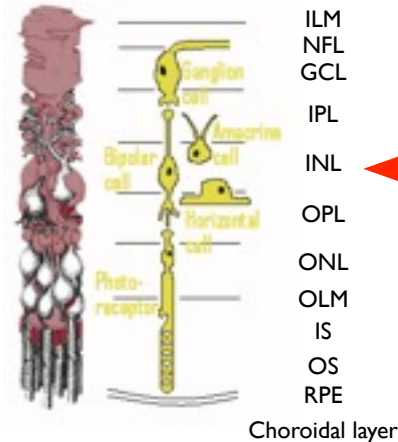

Fig. 26 The ERG of a cat in response to a flash of light. The components a, b, and c are labeled. (From Arden, 1985)

1993

1980

1984

1985

1973

The most effective are potassium ions (Miller, 1973)

The idea that the b-wave results from changes in the membrane potential of the Müller cells due to light-induced changes of extracellular potassium concentration, underlies the basis for the "**Müller-cell Hypothesis**".



# The origin of the major ERG waves.

## The b-wave

- It was assumed that the origin of potassium increases **in the outer plexiform layer** was bipolar cells, most specifically ON-center bipolar cells that were depolarized by light (Dick and Miller, 1985).
- **In the inner plexiform layer**, the increase in extracellular potassium resulted from light-induced activity of amacrine and ganglion cells (Karwoski and Proenza, 1977; Dick and Miller, 1985).
- The change in potassium alters the membrane potential of Müller cells, generating electrical currents in these two regions of the Müller cell, and exiting through its distal and proximal ends (Ripps and Witkovsky, 1985).
- **Depth recordings** of extracellular concentration of potassium and of local field potentials clearly show a reduction of potassium ions in the photoreceptor layer and an increase in the outer and inner plexiform layers.

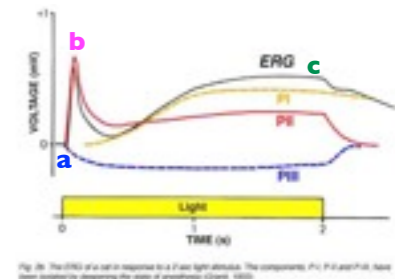
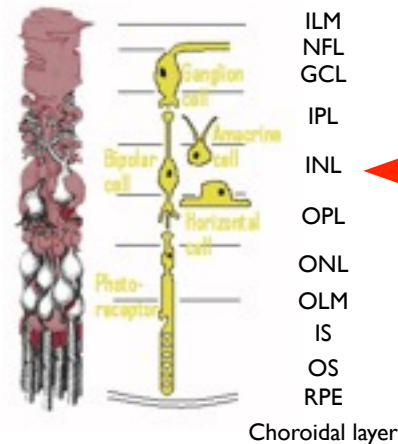

Fig. 6b. The ERG of a cat in response to a flash of light stimulus. The components P1, P1 and P1b have been identified by measuring the state of membrane currents. (1985)

1993

1980

1984

1985

1973

The most effective are potassium ions (Miller, 1973)

The idea that the b-wave results from changes in the membrane potential of the Müller cells due to light-induced changes of extracellular potassium concentration, underlies the basis for the "**Müller-cell Hypothesis**".

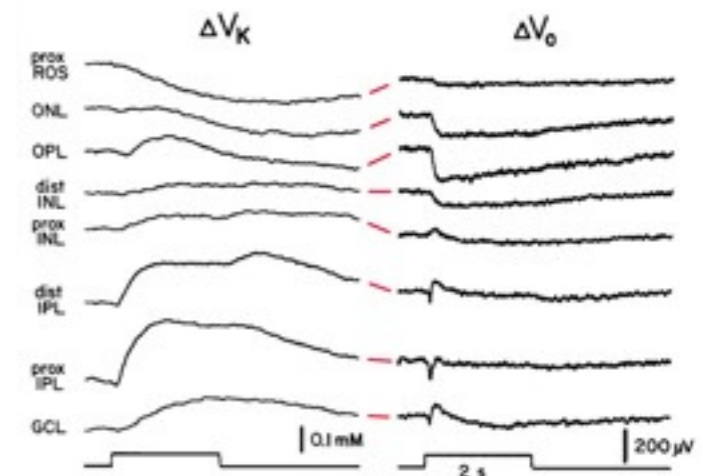

Fig. 7a. The Müller cell hypothesis of the ERG b-wave. Depth profile of light-induced changes in the extracellular concentration of potassium ions ( $\Delta V_K$ ) and of local field potential ( $\Delta V_0$ ) (Karwoski et al., 1985).

# The origin of the major ERG waves.

## The b-wave

- It was assumed that the origin of potassium increases **in the outer plexiform layer** was bipolar cells, most specifically ON-center bipolar cells that were depolarized by light (Dick and Miller, 1985).
- **In the inner plexiform layer**, the increase in extracellular potassium resulted from light-induced activity of amacrine and ganglion cells (Karwoski and Proenza, 1977; Dick and Miller, 1985).
- The change in potassium alters the membrane potential of Müller cells, generating electrical currents in these two regions of the Müller cell, and exiting through its distal and proximal ends (Ripps and Witkovsky, 1985).
- **Depth recordings** of extracellular concentration of potassium and of local field potentials clearly show a reduction of potassium ions in the photoreceptor layer and an increase in the outer and inner plexiform layers.
- **Current source-density** analysis of these data led to the pathways of the extracellular currents to underlie the generation of the ERG b-wave. The two sinks (OPL and IPL) reflect the increase in extracellular potassium ions due to light-induced electrical activity. The vitreous serves as a large current source due to the high potassium conductance of the endfeet of the Müller cells (Newman, 1985).

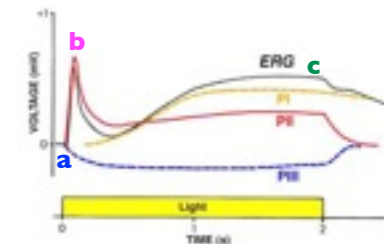
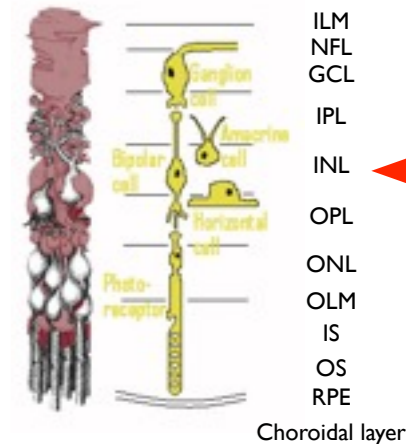

Fig. 6b. The ERG of a cat in response to a flash of light stimulus. The components PI, PII and PIII have been identified by measuring the state of membrane currents (1985).

1993

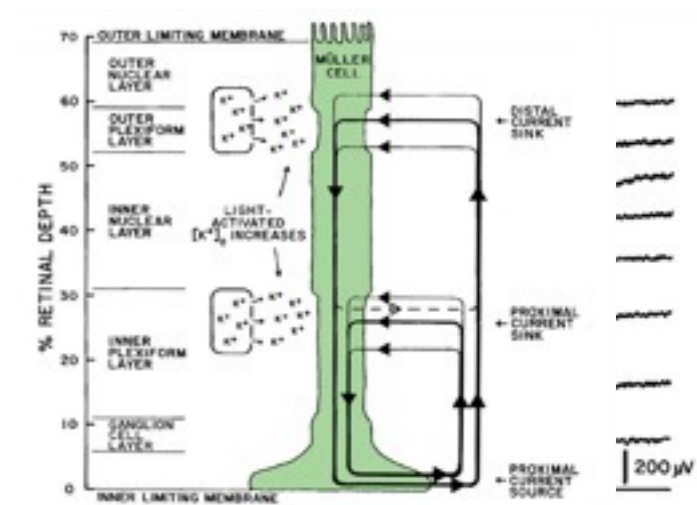

Fig. 7b. The pathways of the extracellular currents that have been suggested to underlie the generation of the ERG b-wave. The two sinks (OPL and IPL) reflect the increase in extracellular potassium ions due to light-induced electrical activity. The vitreous serves as a large current source due to the high potassium conductance of the endfeet of the Müller cells.

1973  
The most effective are potassium ions (Miller, 1973)

The idea that the b-wave results from changes in the membrane potential of the Müller cells due to light-induced changes of extracellular potassium concentration, underlies the basis for the "**Müller-cell Hypothesis**".



# The origin of the major ERG waves.

## The b-wave

- Exposing the vertebrate retina to 2-amino-4-phosphonobutyric acid (APB), a specific agonist of glutamate metabotropic receptors, **eliminates** the ERG b-wave (Gurevich and Slaughter, 1993).
- Since APB-sensitive metabotropic glutamate receptors are found **only** in ON-center bipolar cells (Slaughter and Miller, 1981), this finding constitutes a clear indication of the involvement of these bipolar cells in the generation of the b-wave.
- Further support came from experiments in which the effects of 6,7-dinitroquinoxaline-2,3-dione (DNQX) upon the ERG were tested.
- This drug is a specific antagonist to AMPA/KA type glutamate receptors, and enhances the b-wave, probably by removing current sources that oppose those forming the b-wave.

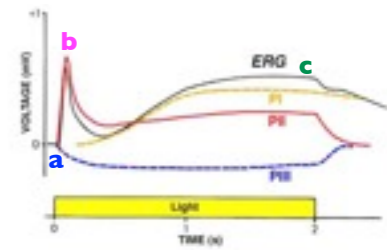
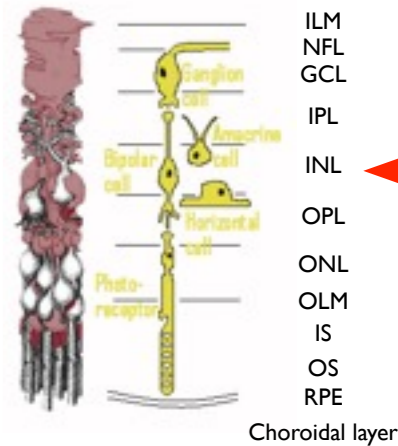

wave results from changes in the of the Müller cells due to light-of extracellular potassium lies the basis for the "**Müller-cell**

More evidence concerning the source of the ERG b-wave was gained with specific agonists and antagonists to glutamate receptors.



1984 1985

1993

1999



# The origin of the major ERG waves.

## The b-wave

- This led to a "push-pull model" of these cell types (Sieving et al., 1994).
- More recent detailed sink-source analyses (Karwoski and Xu, 1999), pharmacological dissection of the ERG (Green and Kapousta-Bruneau, 1999) and experiments with mGluR6 knockout mice (Masu et al. 1995) points directly to the ON-center bipolar cells as generating the ERG b-wave **without** the Müller cells.
- This observation (and others using barium) opposes the Müller cells hypothesis for the ERG b-wave and thus, supports the **“ON-center bipolar cell hypothesis”**.

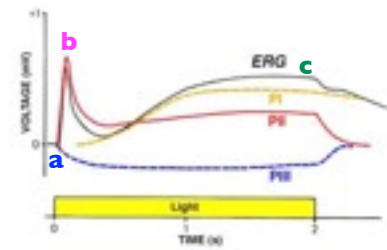
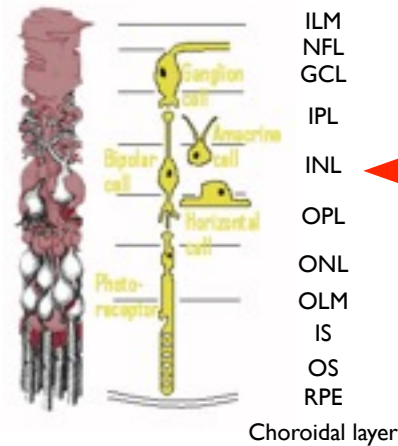
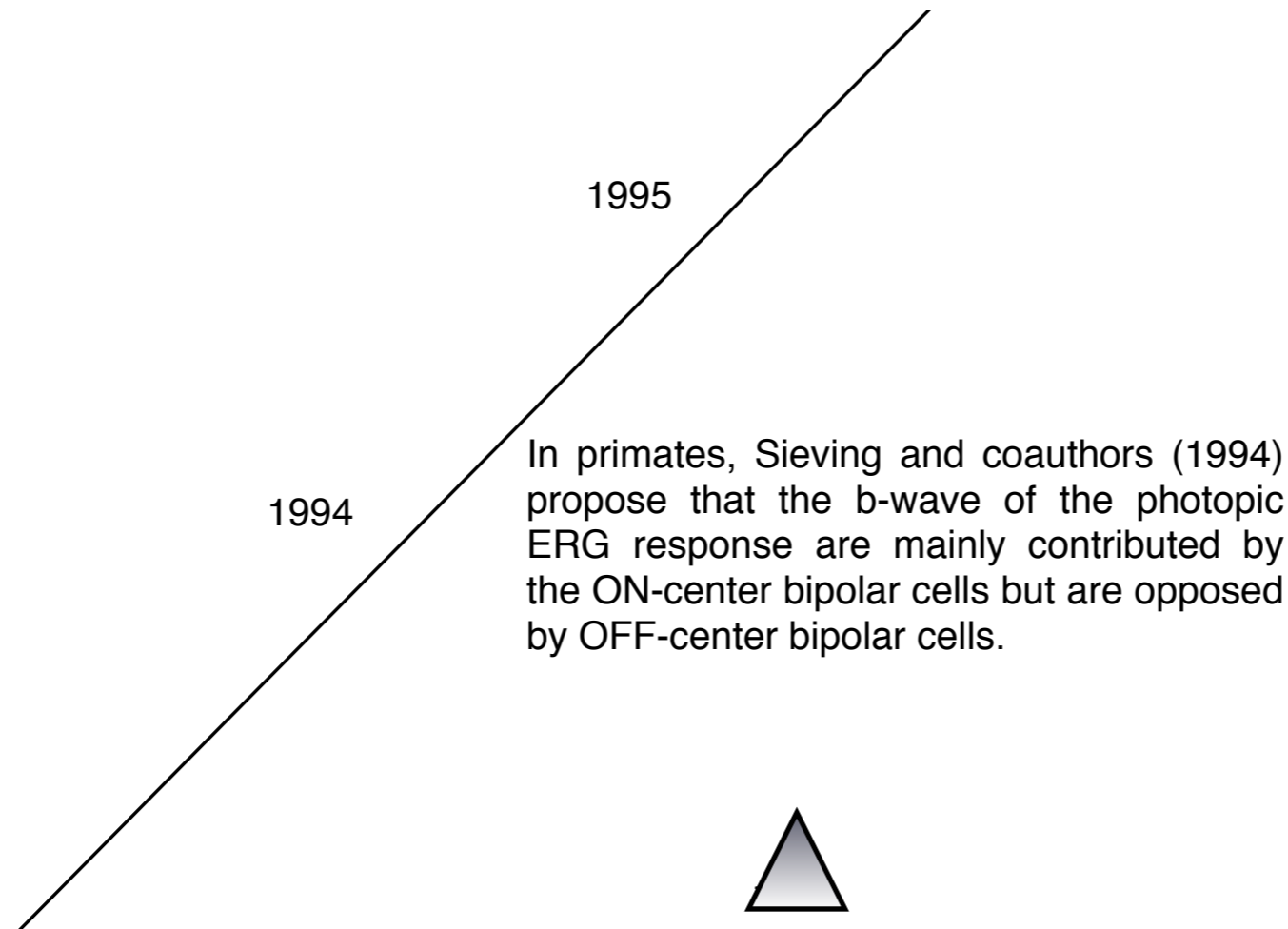

Fig. 26 The ERG of a cat in response to a flash of light. The components a, b, and c are shown. (Green, 1985)



# The origin of the major ERG waves.

## The b-wave

- Another study on the retina-eyecup preparation of the tiger salamander, shows that drugs disrupts the activity of third order neurons and causes enhancement of the b-wave (Awatramani et al., 2001).
- The b-wave is also found to be **affected by drugs** that modulate GABAC-type receptors indicating that negative feedback from amacrine cells onto bipolar cells can shape the photoresponses of the bipolar cells and thus, the amplitude and kinetics of the ERG b-wave (Dong and Hare, 2002).
- GABAA and GABAC pathways are also found to affect the ERG b-wave of the rat retina (Kapousta-Bruneau, 2000).
- Bicuculline, the antagonist for GABAA-type receptors augments the b-wave, while, 3-aminopropylphosphono acid (3-APMPA), the antagonist for GABAC-type receptors reduces it.

Using tetrodotowin (TTX) to block action potentials in third-order retinal neurons (amacrine and ganglion cells), and specific antagonists to GABA and glycine receptors, it was concluded that third-order neurons contributed to the amplitude and kinetics of the ERG b-wave (Dong and Hare, 2000).

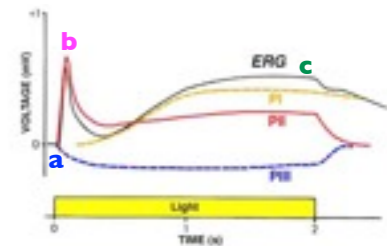
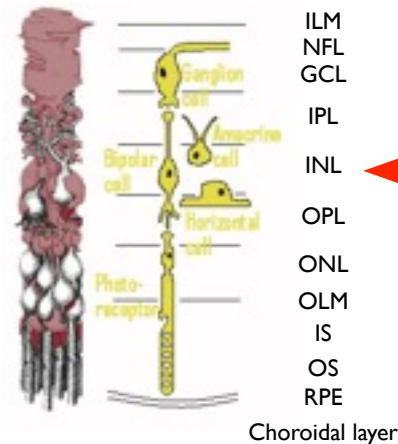
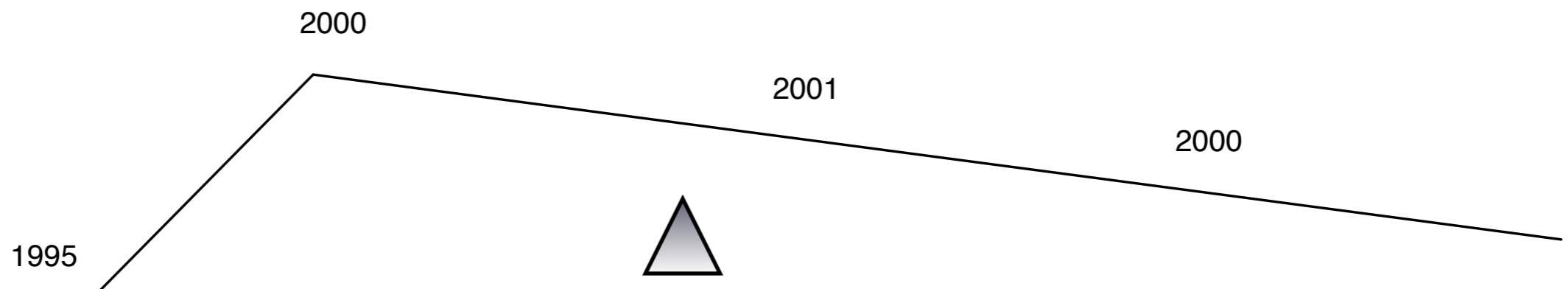

Fig. 20. The ERG of a cat in response to a flash of light stimulation. The components a, b, and c are labeled by measuring the slope of the individual waves. (1980)



# The origin of the major ERG waves.

## The b-wave

- **ON-center bipolar cells generate the ERG b-wave without the Müller cells.**
- **Third-order neurons (amacrine and ganglion cells) contribute to the amplitude and kinetics of the ERG b-wave.**
- **The b-wave is found to be affected by drugs that modulate GABAC-type receptors**

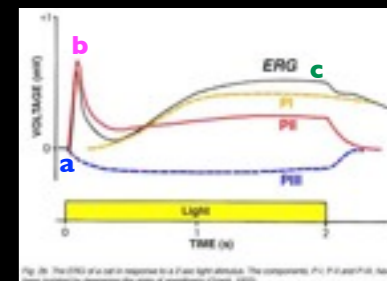
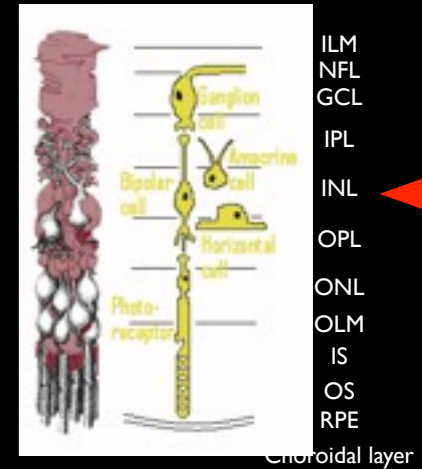

Fig. 20. The ERG of a cat in response to a 2 msec light stimulus. The components P1, P2 and P3 have been identified according to the work of Goldmann (1955).